

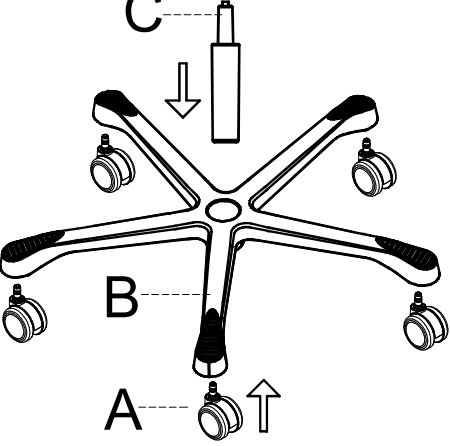

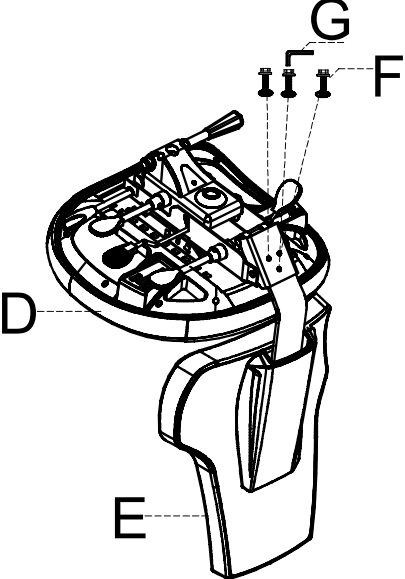

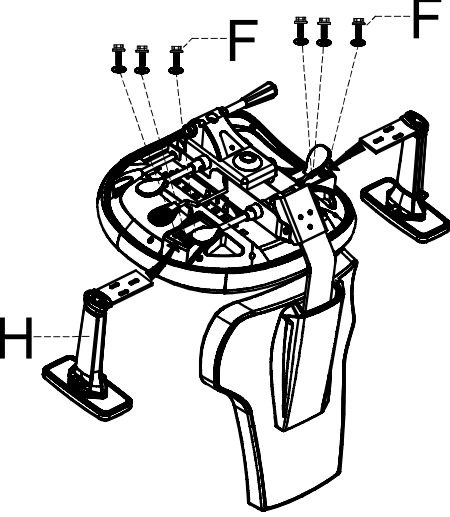





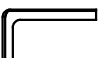
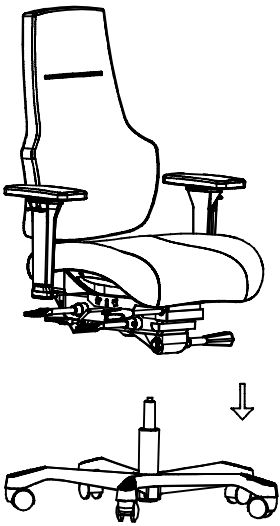
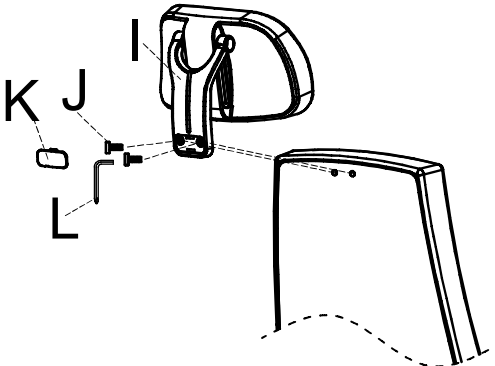

# ASSEMBLY INSTRUCTION / MONTÁŽNÍ NÁVOD

BEFORE USE AND ASSEMBLY THIS PRODUCT, PLEASE READ THIS INSTRUCTION CAREFULLY / PŘED POUŽITÍM A MONTÁŽÍ TOHOTO VÝROBKU SI PROSÍM POZORNĚ PŘEČTĚTE TENTO NÁVOD

Part	Picture	Qty.	1	2	3
A		5			
B		1			
C		1			
D		1			
E		1			
F	 M8x20	9			
G		1			
H		2			
I		1			
J	 M6x20	2			
K		1			
L		1			

## Headrest adjustment:

To rise: Hold the headrest (①) with both hands and lift it up to a suitable height.  
 To lower: Hold the headrest with both hands and pull it down to a suitable height.  
 To adjust the headrest angle: Hold the headrest with both hands and turn it to a suitable angle.

## Back height adjustment:

To rise: Hold the bottom of the chair back (②) with both hands and lift it up to a suitable height step by step.  
 To lower: Hold the bottom of the chair back with both hands and lift it step by step. After crossing the highest position, the back can be lowered to the lowest position.  
 Attention: Backrest can NOT lower down during the adjustment to upward; Only can lower down to lowest position when reaching the highest position and release your hands.

## Armrest adjustment (③):

Armrest height: Pull up the button while holding the armrest and lift it up or lower it down.  
 Armrest forward/backward: Grasp the armrest and slide forward or backward.  
 Armrest angle: Grasp the armrest and pivot to the left or right.  
 Armrest width: Grasp the armrest and press the button under the armrest, move horizontal to the left or right.

## Seat height adjustment (④):

To raise: Lift up the lever when leaving or half up, release the lever when reaching a desired height.  
 To lower: While seated, lift the lever up, release the lever when reaching a desired height.

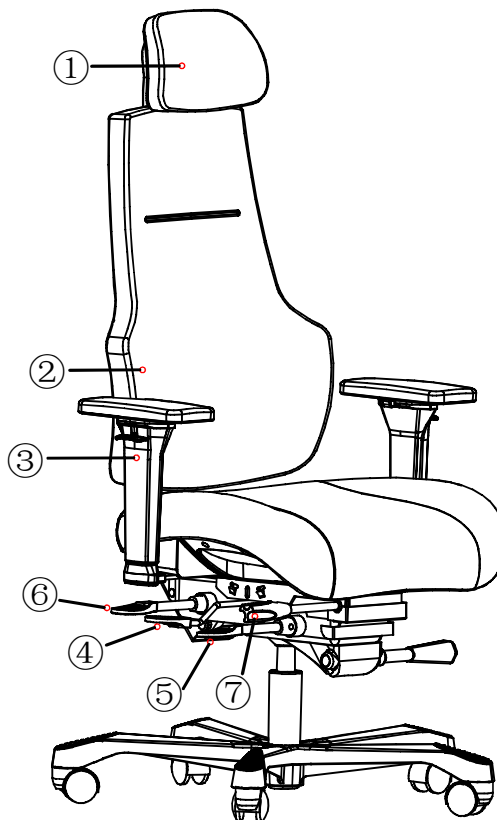

## Tilt angle adjustment (Tilt/Swing Lock) (⑤):

To unlock: Pull up the adjustment lever.  
 To lock: Push down the adjustment lever when reaching a desired angle.

## Independent backrest angle adjustment (⑥):

To unlock: Pull up the adjustment lever.  
 To lock: Push down the adjustment lever when reaching a desired angle.

## Seat angle adjustment (⑦):

To lift up: Turn anticlockwise the seat angle adjustment handle.  
 To lower down: Turn clockwise the seat angle adjustment handle.

Tips: When using this function, please sit on the chair, lie back to keep the chair body at a recline posture, then it is easier to turn the handle.

## Tilt tension adjustment (⑧):

To increase: Turn the knob clockwise/forward to stronger.  
 To reduce: Turn the knob anticlockwise/backward to weaker.

## Seat depth adjustment (⑨):

To increase: While seated and pull up the lever, at the same time, push your hips forward to slide the seat cushion to a proper position, and then release the lever.  
 To reduce: When leaving or half up, pull up the lever, and the seat cushion can return to the rear position, or release the lever when it reaches the desired position.

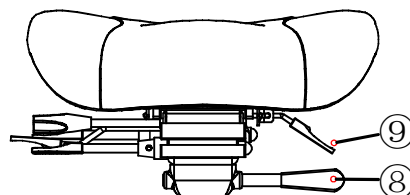

## Headrest adjustment:

To rise: Hold the headrest (①) with both hands and lift it up to a suitable height.  
 To lower: Hold the headrest with both hands and pull it down to a suitable height.  
 To adjust the headrest angle: Hold the headrest with both hands and turn it to a suitable angle.

## Back height adjustment:

To rise: Hold the bottom of the chair back (②) with both hands and lift it up to a suitable height step by step.  
 To lower: Hold the bottom of the chair back with both hands and lift it step by step. After crossing the highest position, the back can be lowered to the lowest position.  
 Attention: Backrest can NOT lower down during the adjustment to upward; Only can lower down to lowest position when reaching the highest position and release your hands.

## Armrest adjustment (③):

Armrest height: Pull up the button while holding the armrest and lift it up or lower it down.  
 Ampad forward/backward: Grasp the armpad and slide forward or backward.  
 Armpad angle: Grasp the armpad and pivot to the left or right.  
 Armrest width: Grasp the armpad and press the button under the armpad, move horizontal to the left or right.

## Seat height adjustment (④):

To raise: Lift up the lever when leaving or half up, release the lever when reaching a desired height.  
 To lower: While sitted, lift the lever up, release the lever when reaching a desired height.

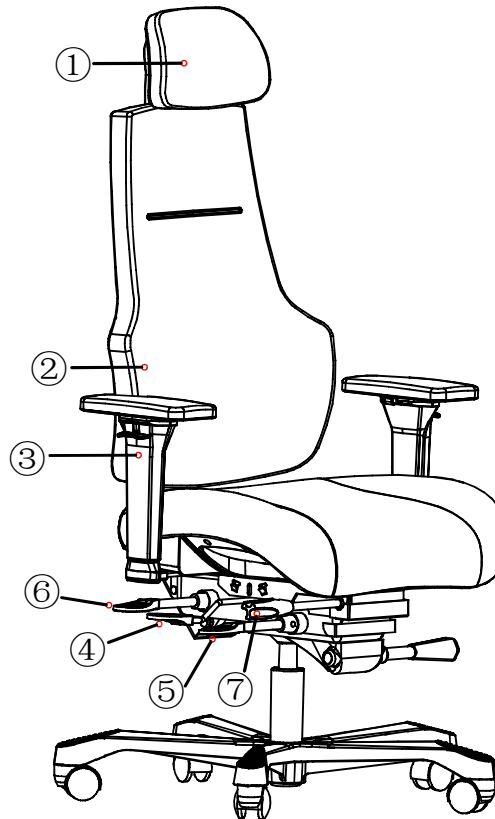

## Tilt angle adjustment (Tilt/Swing Lock) (⑤):

To unlock: Pull up the adjustment lever.  
 To lock: Push down the adjustment lever when reaching a desired angle.

## Independent backrest angle adjustment (⑥):

To unlock: Pull up the adjustment lever.  
 To lock: Push down the adjustment lever when reaching a desired angle.

## Seat angle adjustment (⑦):

To lift up: Turn anticlockwise the seat angle adjustment handle.  
 To lower down: Turn clockwise the seat angle adjustment handle.

Tips: When using this function, please sit on the chair, lie back to keep the chair body at a recline posture, then it is easier to turn the handle.

## Tilt tension adjustment (⑧):

To increase: Turn the knob clockwise/forward to stronger.  
 To reduce: Turn the knob anticlockwise/backward to weaker.

## Seat depth adjustment (⑨):

To increase: While sitted and pull up the lever, at the same time, push your hips forward to slide the seat cushion to a proper position, and then release the lever.  
 To reduce: When leaving or half up, pull up the lever, and the seat cushion can return to the rear position, or release the lever when it reaches the desired position.

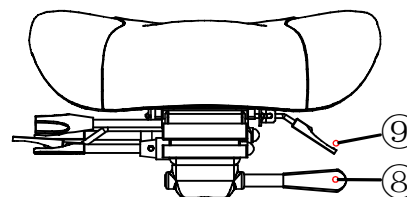

## ENG

Upholstery maintenance is performed by cleaning with a fine brush in the direction of the main fibers, wiping dirt with a damp cloth with soapy water or shampooing. The composition of the cover material is 100% polyester (PES).

We recommend checking the tightening of the screws every 3 months.

The chair is intended for sitting in three-shift operation, in surveillance centers, control rooms and longer applications with multi-shift interior operation.

A warranty period of 60 months is valid for this type of use. During the warranty period, the manufacturer will replace free of charge all parts that have been damaged by a material defect or due to a manufacturing error. In these cases, the manufacturer replaces the defective parts, not the entire chair.

The load capacity of the chair is up to 200 kg.

The warranty does not cover damage caused by:

- by transport (the carrier is responsible for these damages)
- a natural disaster
- incorrect assembly
- careless and inappropriate use
- by not following the given instructions

We believe you will be satisfied with our product.



ANTARES a.s.

## CZE

Údržba potahové látky se provádí očištěním jemným kartáčem ve směru hlavních vláken, setřením nečistot vlhkým hadrem s mýdlovou vodou případně šamponováním. Složení potahové látky je 100%polyester (PES).

Doporučujeme každé 3 měsíce provádět kontrolu dotažení šroubů.

Židle je určena k sezení v třísměnném provozu, v dohledových centrech, velínech a dalších aplikacích s vícesměnným interiérovým provozem.

Záruční lhůta 60 měsíců je platná u tohoto druhu použití. Během platnosti záruky výrobce nahradí bezplatně všechny části, které byly poškozeny vadou materiálu nebo zásluhou chyby při výrobě. Výrobce v těchto případech nahrazuje vadné části nikoliv celé židle.

Nosnost židle je max. do 200 kg.

Záruka se nevztahuje na škody způsobené:

- dopravou (za tyto škody odpovídá dopravce)
- přírodní katastrofou
- chybnou montáží
- nedbalým a nepřiměřeným používáním
- nedodržením uvedených pokynů

Věříme, že budete s naším produktem spokojeni.



ANTARES a.s.