















MULTINA

Ax2 	Bx4 	Cx2 	
Dx1 	Ex1 	Fx2 	Gx2 
Hx2 	Ix2 	Jx1 	Kx1 
Lx1 	Nx4 		

①

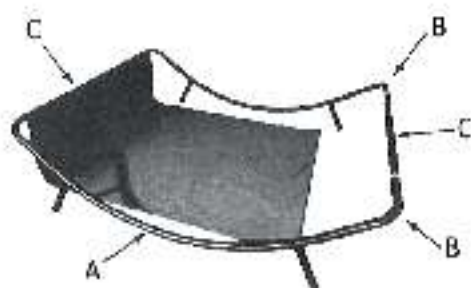

②



③

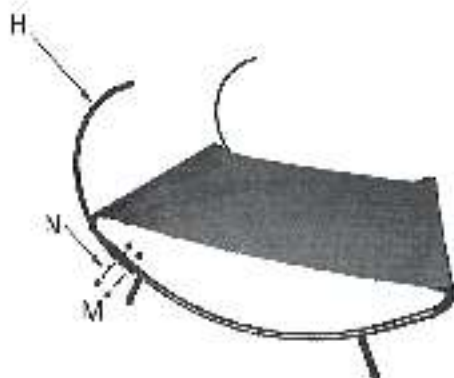

④

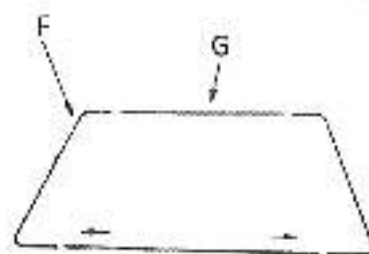

5

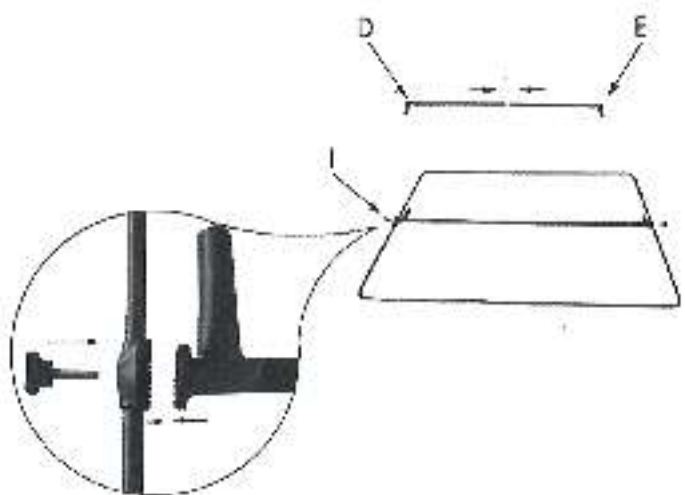

6



7

