

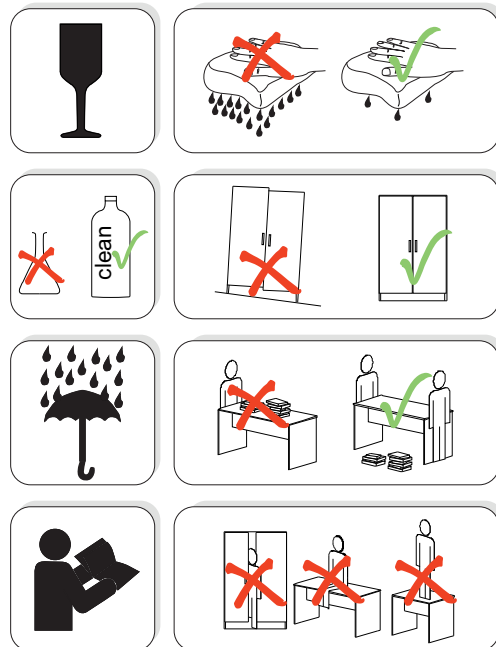

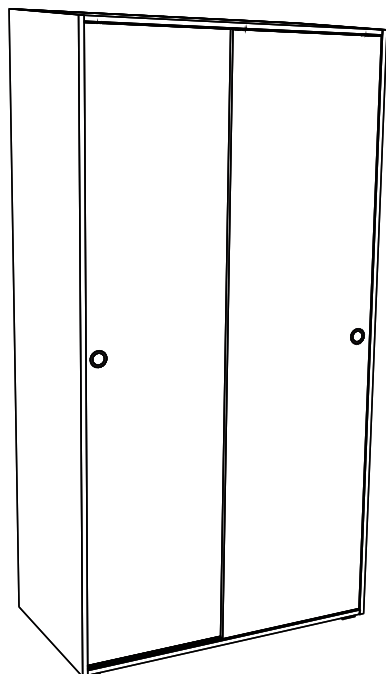











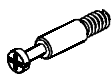

# REA Lary

## S3/200

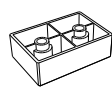
	1000
	2000
	600

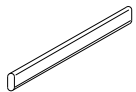

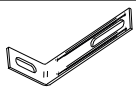
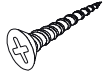
1/1

<b>1</b> 	<b>2</b> 	<b>3</b> 	<b>4</b> 	<b>5</b> 	<b>6</b> 	<b>7</b> 							
kolík 8x35	18ks	úchyt veš. tyče	2ks	ťahlo	26ks	excenter	26ks	krytka	26ks	skrutka zh 3,5x16	13ks	sedlárska podložka	5ks
<b>8</b> 	<b>9</b> 	<b>10</b> 	<b>11</b> 	<b>12</b> 	<b>13</b> 	<b>14</b> 							
unipos horný	4ks	unipos spodný	4ks	klzák Herman	5ks	skrutka zh 5x25	10ks	vešiaková tyč 465 mm	1ks	klíneč 1,2x25	16ks	trojuholník chrbát	10ks
<b>15</b> 	<b>18</b> 	<b>19</b> 											
bezpečnostný uholník	1ks	skrutka zh 3x20	15ks	podperka sklo 5x5	12ks								

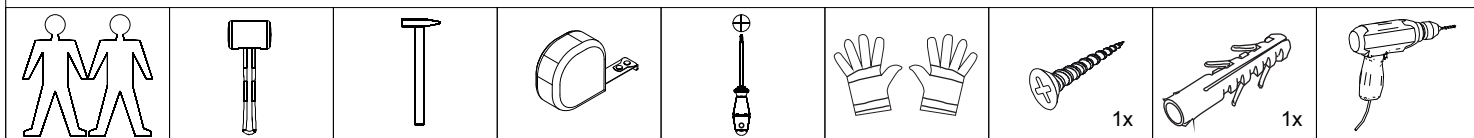

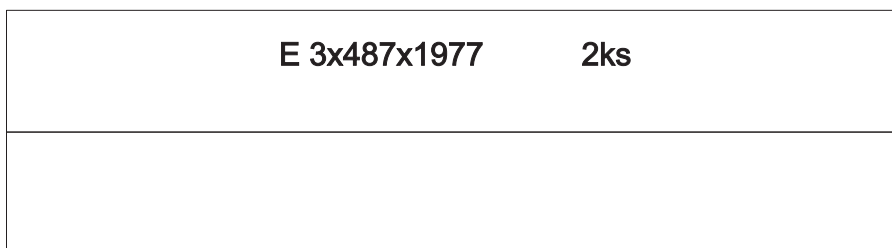
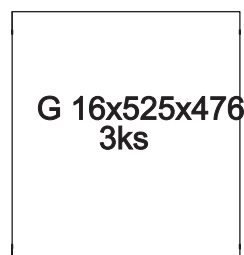
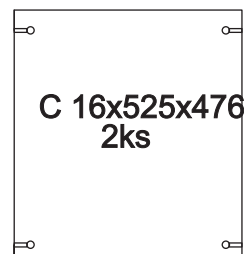
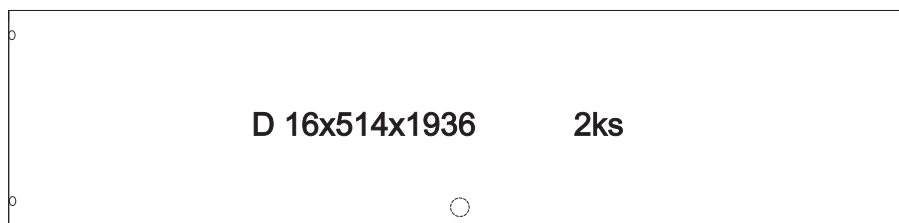
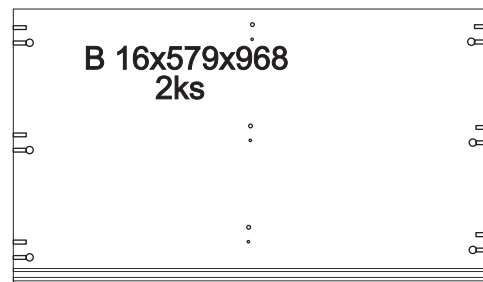
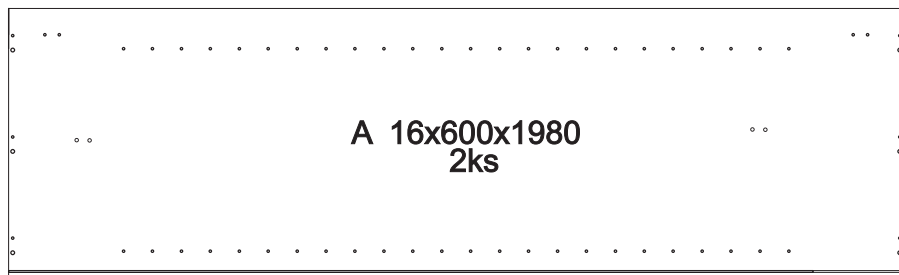

1

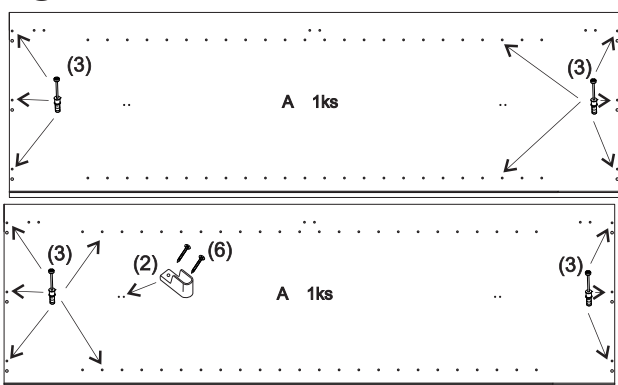

2

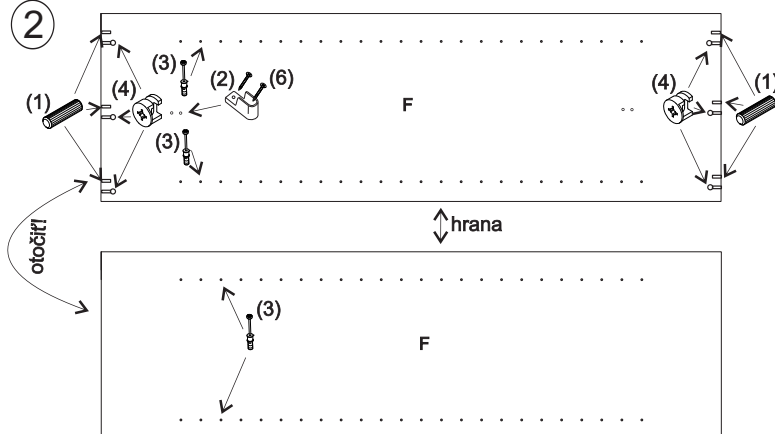

3

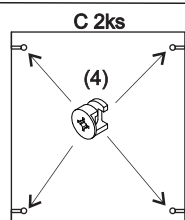

4

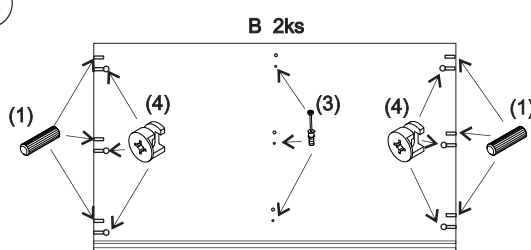

B 1ks

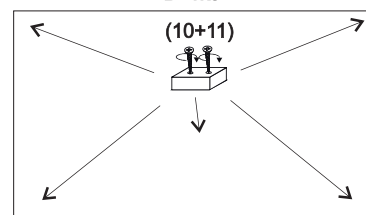

5

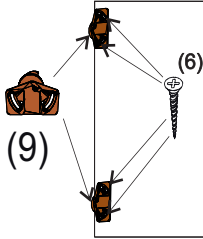

D 1ks-Pravy  
D 1ks-Lavy

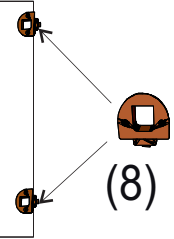

6

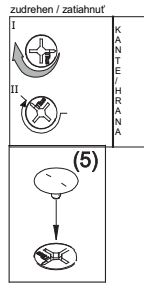
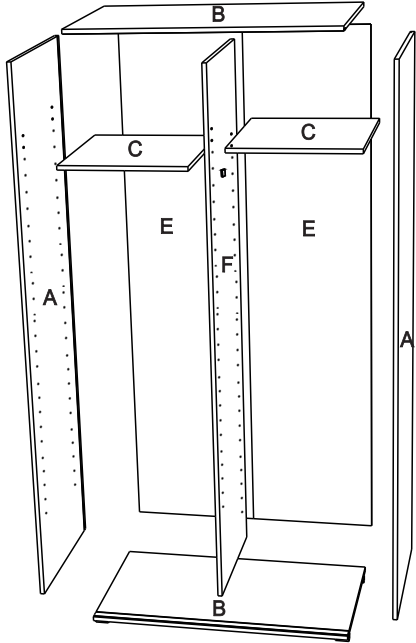

7

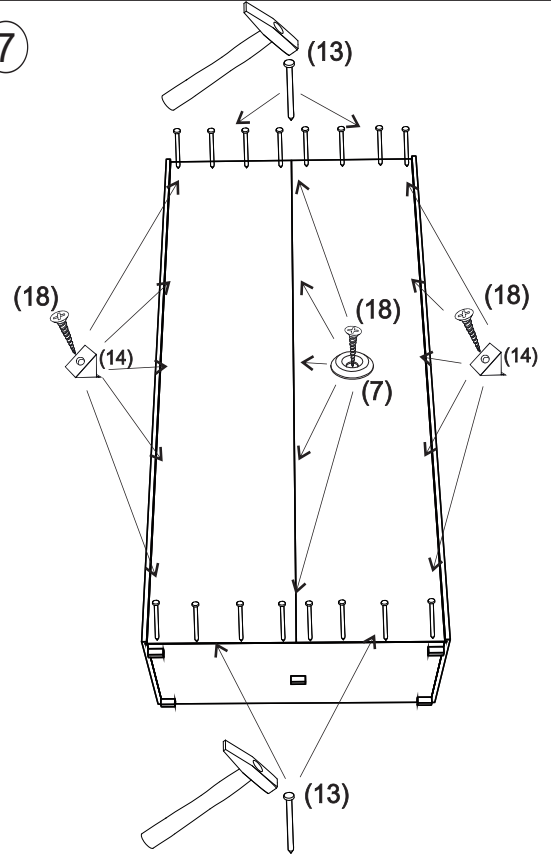

8

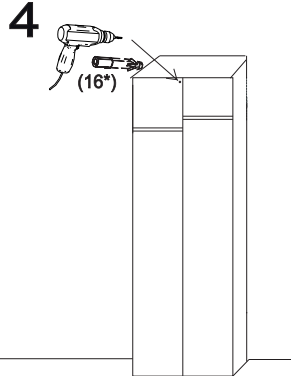
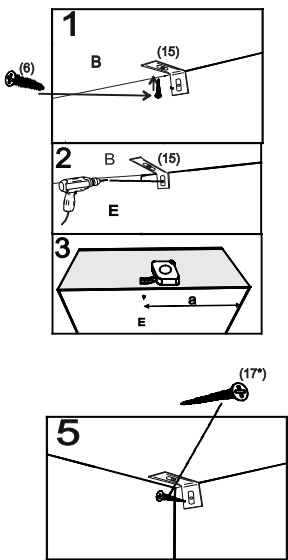

9

