

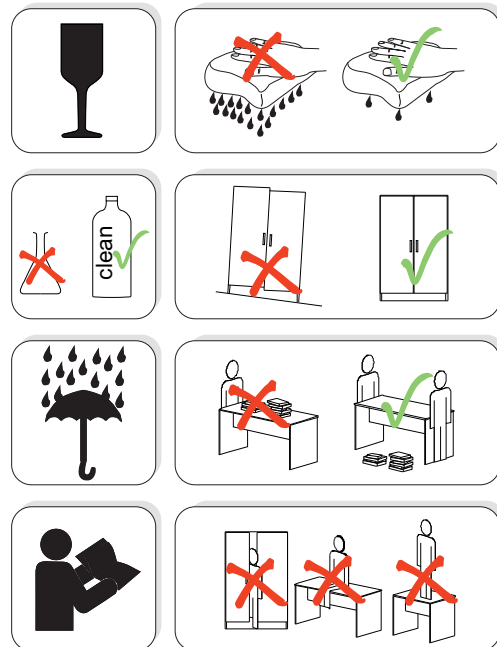

# REA AMY

## 29/180 30/180

	450/600
	1800
	400

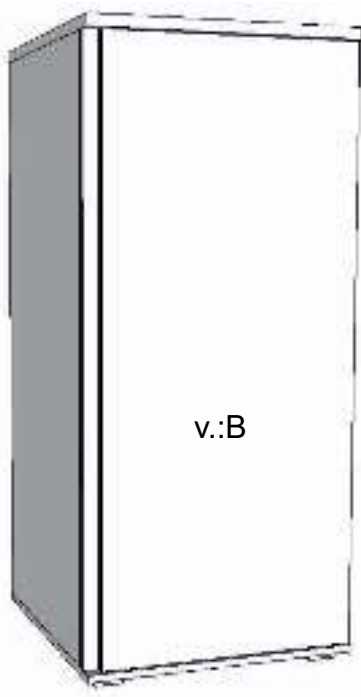
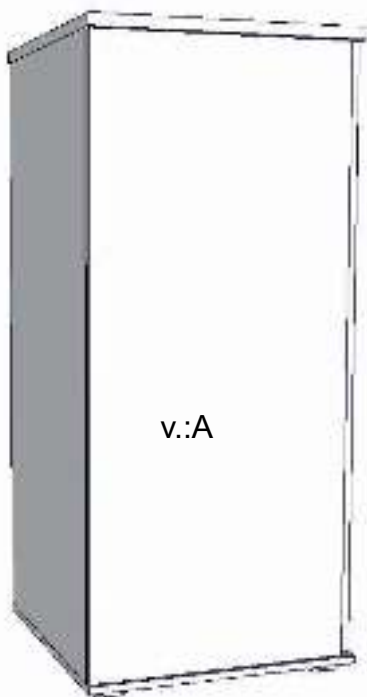

1/1

1		3		5		6		7		8		9	
kolík 8x35	16ks	tiahlo	17ks	excenter	17ks	krytka	17ks	záves naložený	3ks	podložka závesu	3ks	skrutka zh 4x16	7ks
10		11		17		18		24		28		33	
klzák Herman	4ks	klinec 1,2x25	50ks	podperka sklo 5x5	8ks	skrutka zh 5x25	8ks	doraz	2ks	bezpečnostný uhonník	1ks	štetina 1733mm	1ks

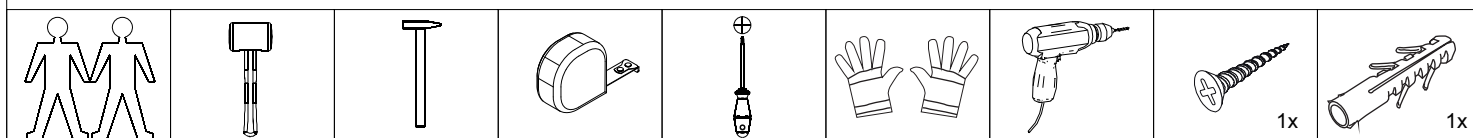

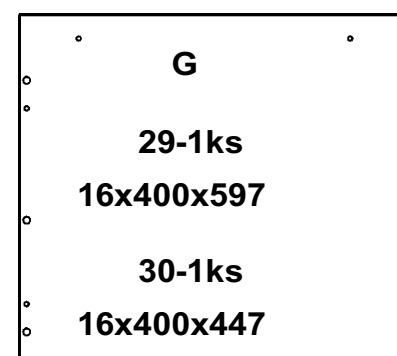
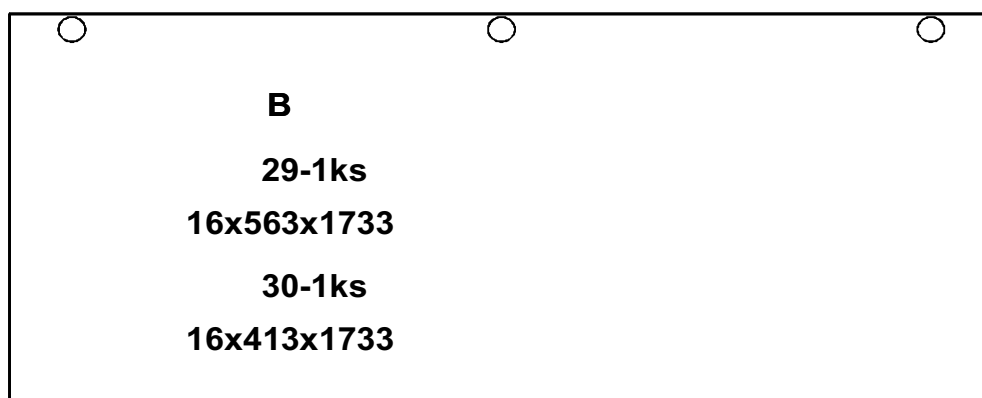
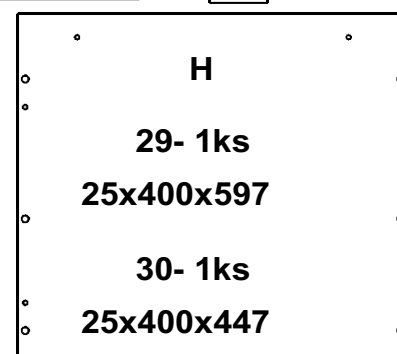
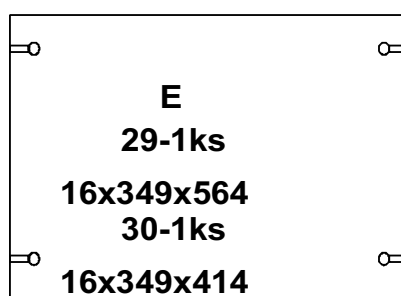
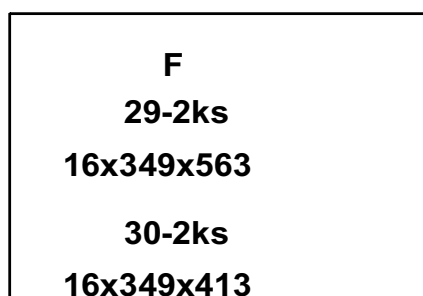
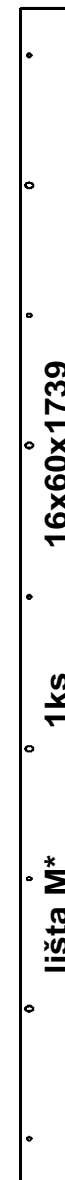
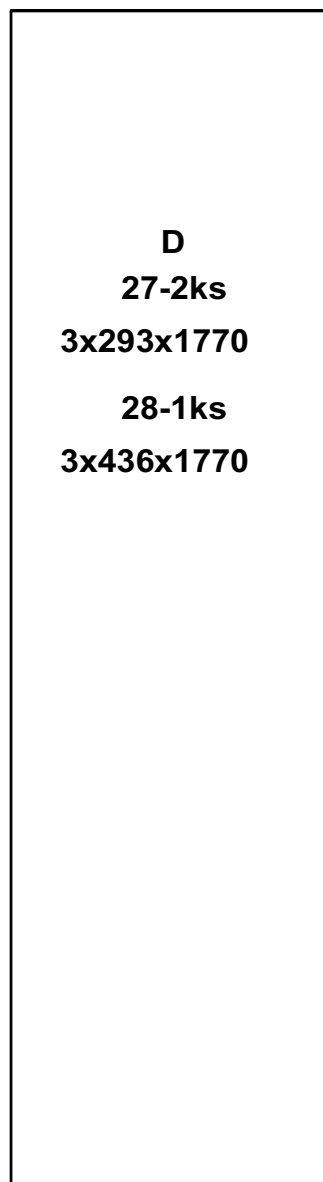
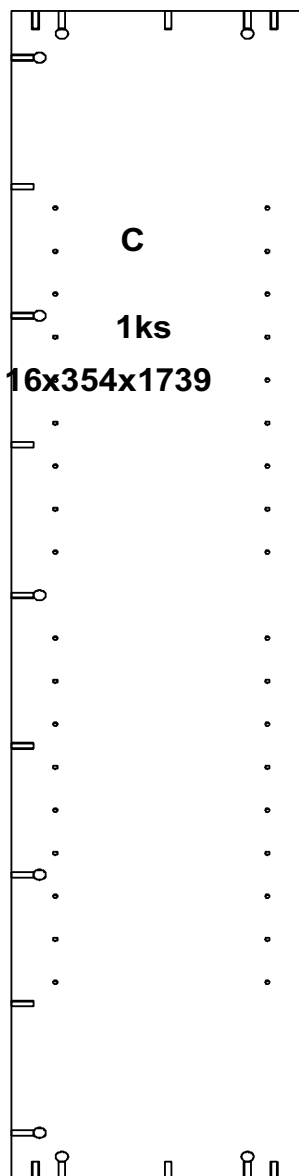
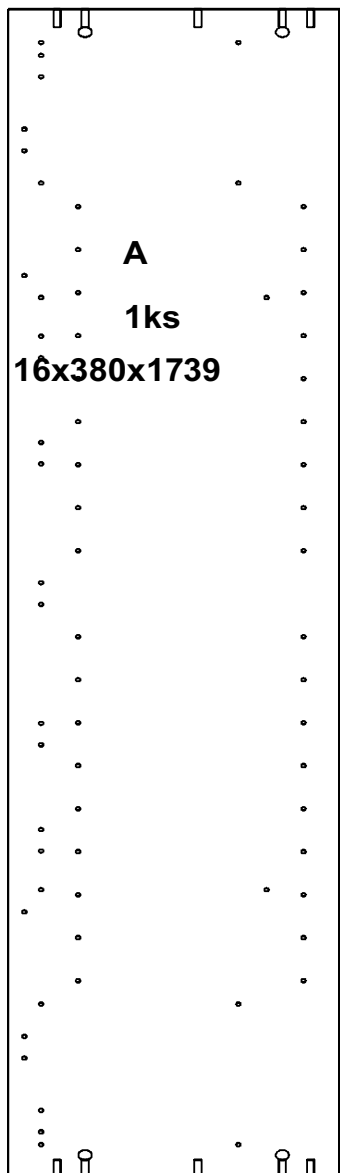

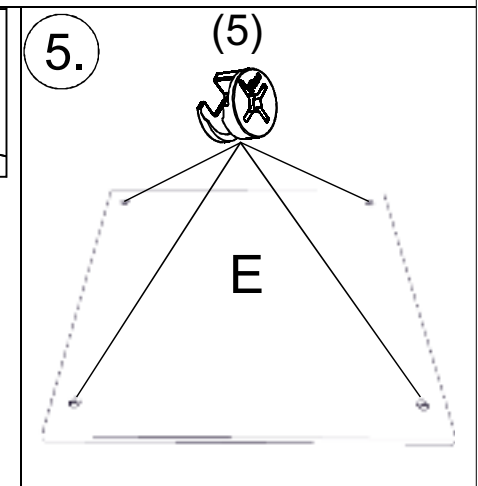
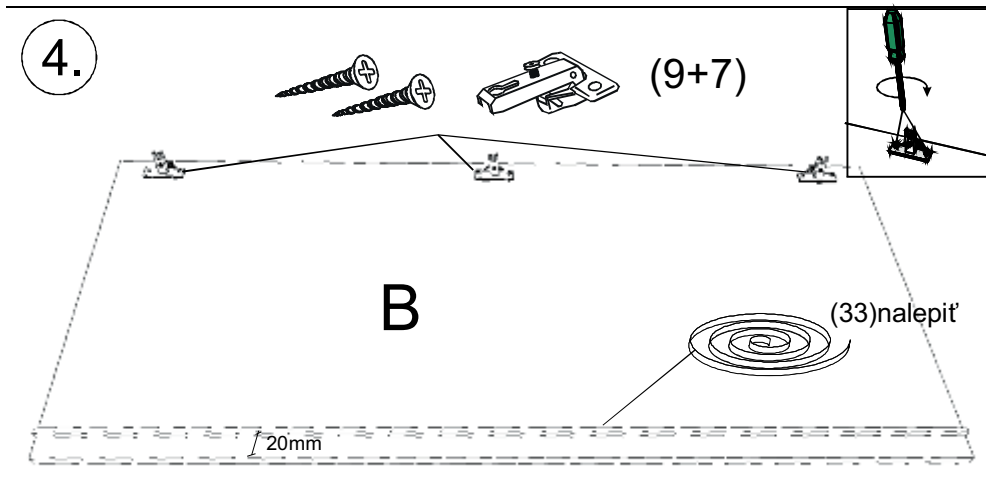
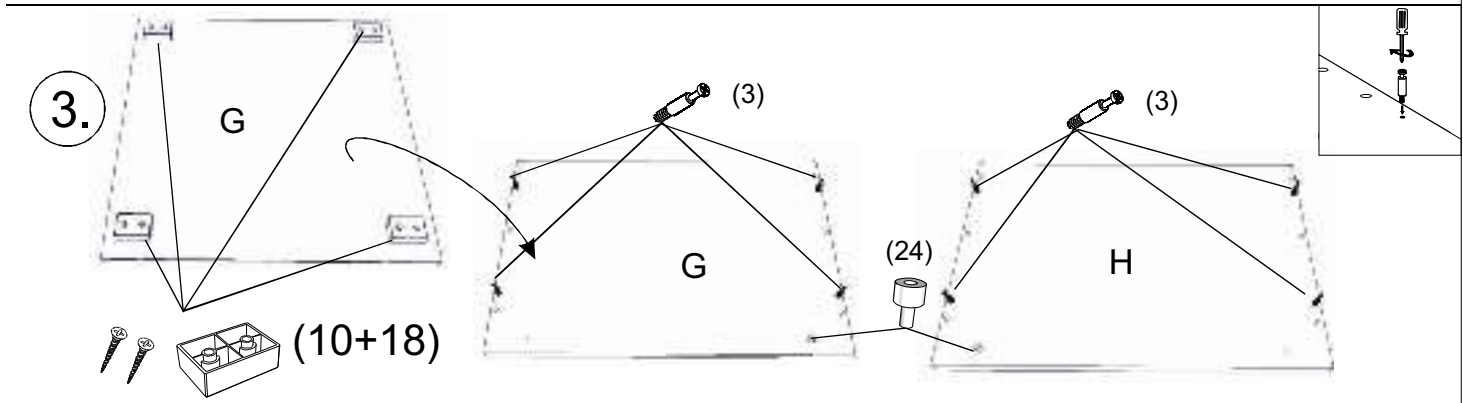
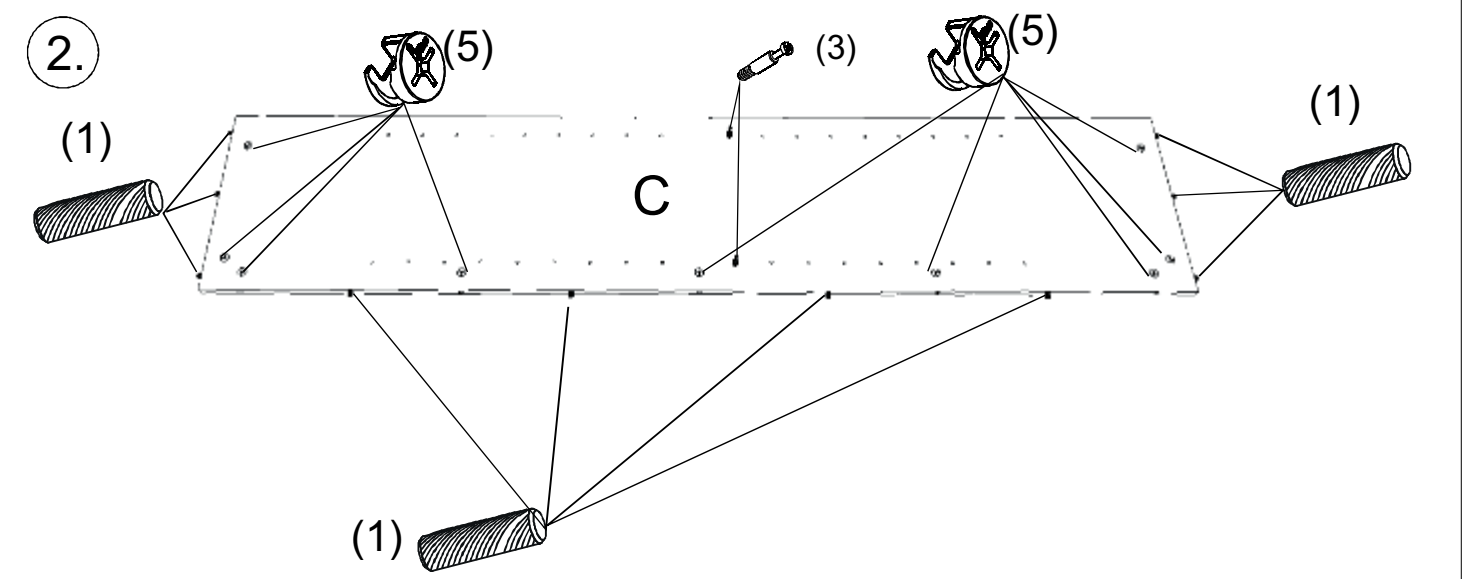
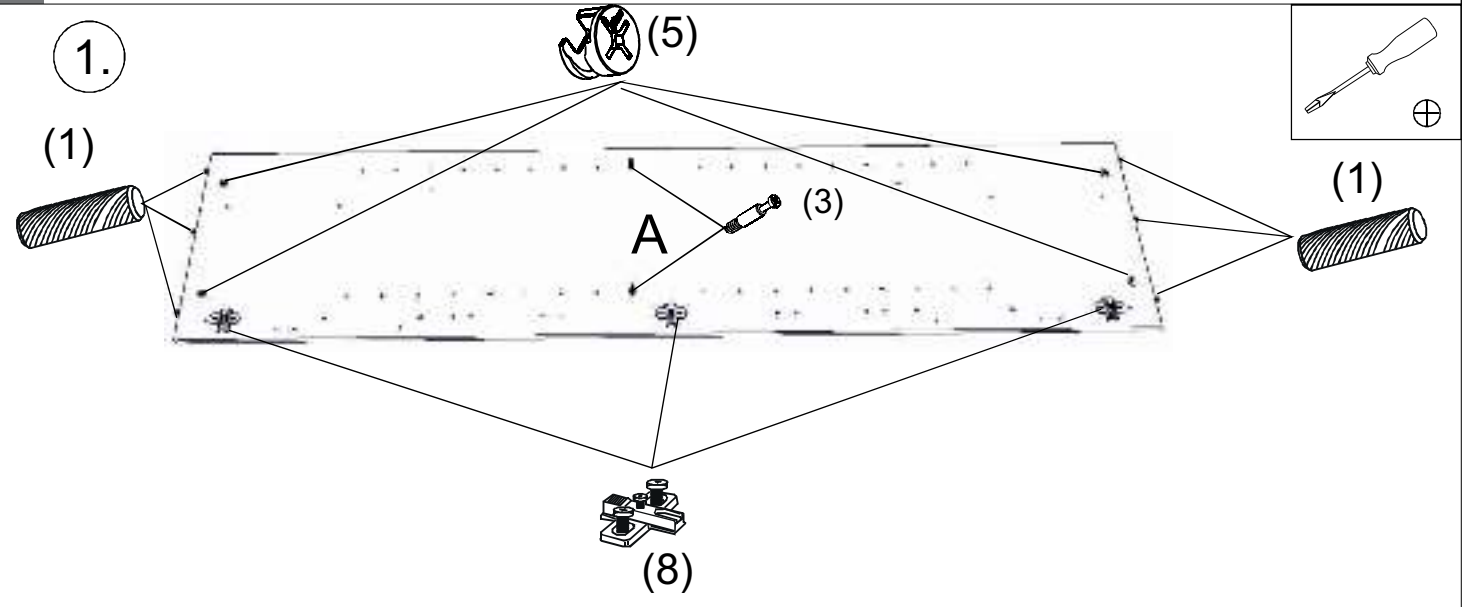

6.

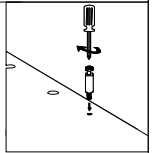
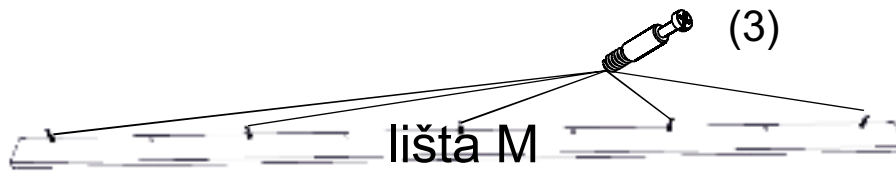

7.

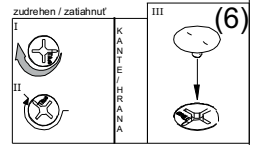
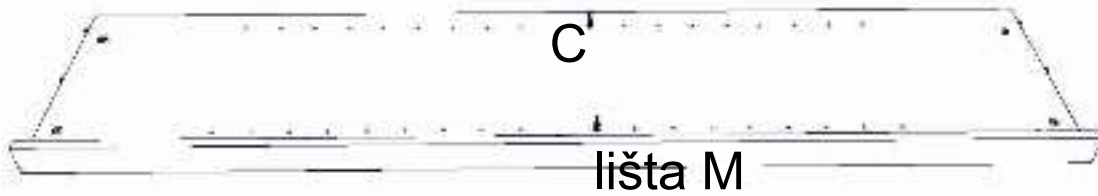

8.

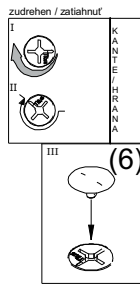
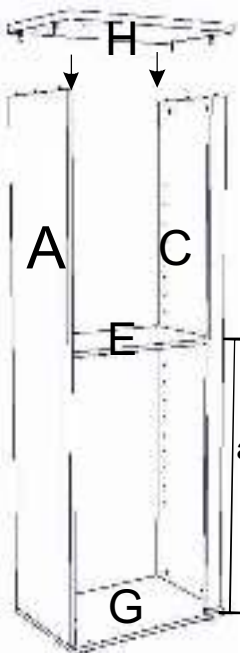

9.

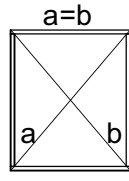
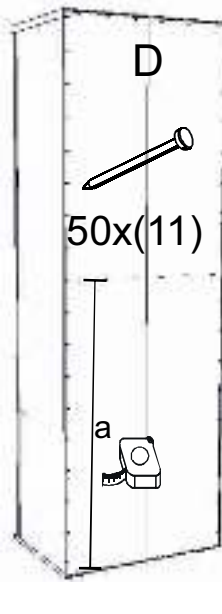

10.

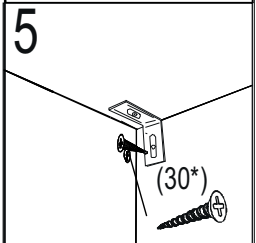
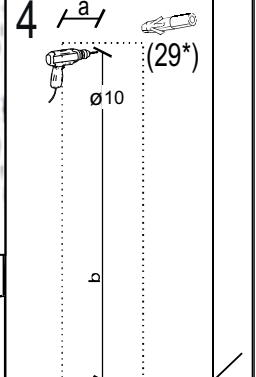
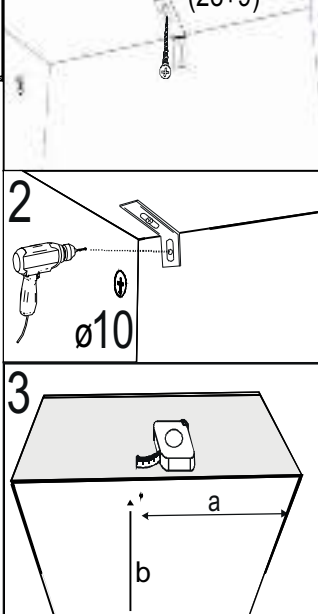

11.

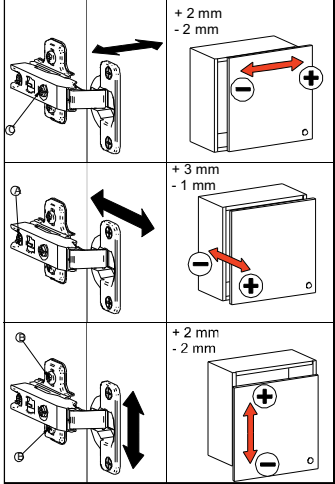
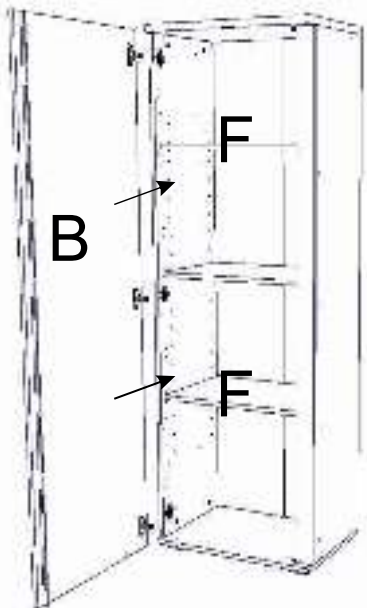

12.

