

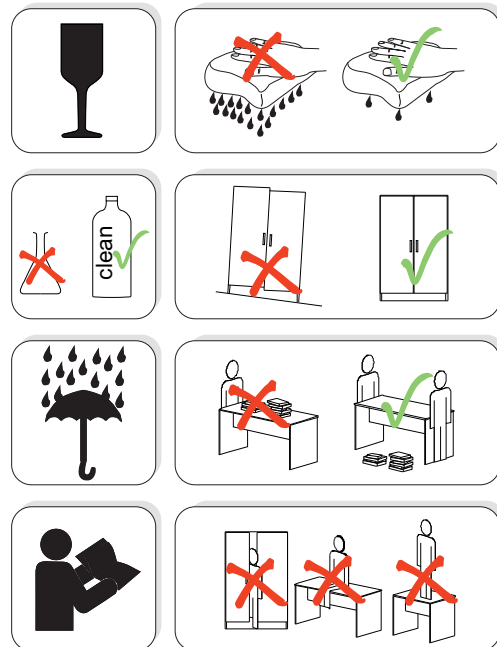

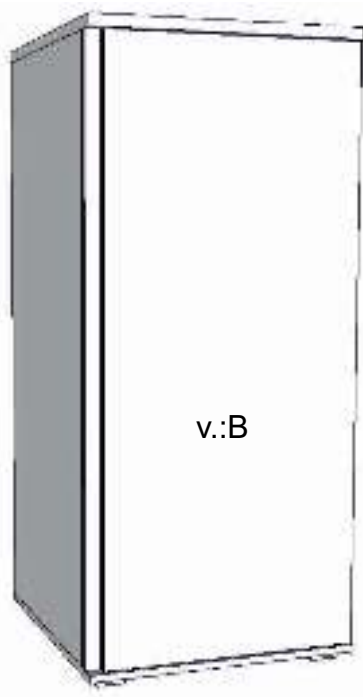

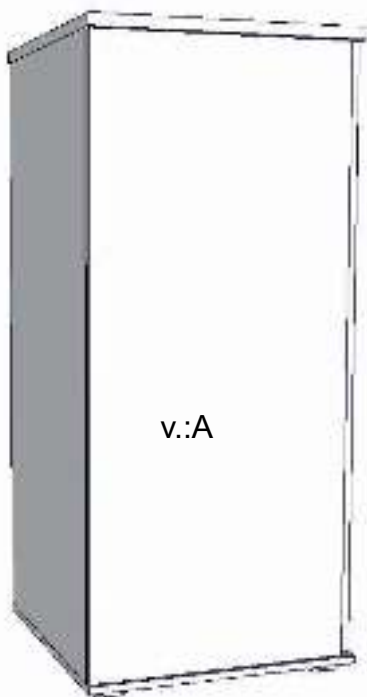









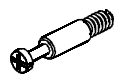

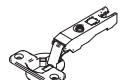
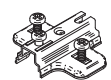
REA AMY

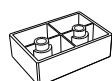
27/180

	600
	1800
	600

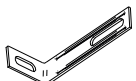

1/1

1		3		5		6		7		8		9	
kolík 8x35	16ks	tiahlo	21ks	excenter	21ks	krytka	21ks	záves naložený	3ks	podložka závesu	3ks	skrutka zh 4x16	11ks
10		11		18		24		28		31		32	
klzák Herman	4ks	klíнец 1,2x25	50ks	skrutka zh 5x25	8ks	doraz	2ks	bezpečnostný uholník	1ks	vešiaková tyč 555 mm	1ks	úchyt veš. tyče	2ks
33													
štetina 1733mm	1ks												

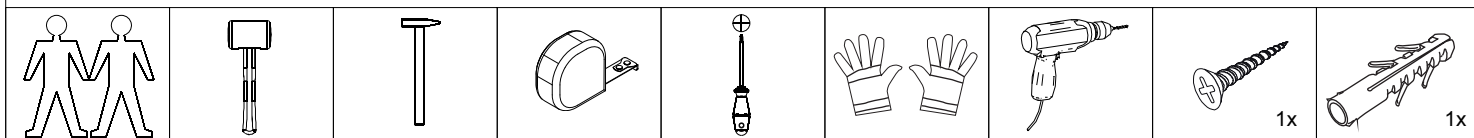

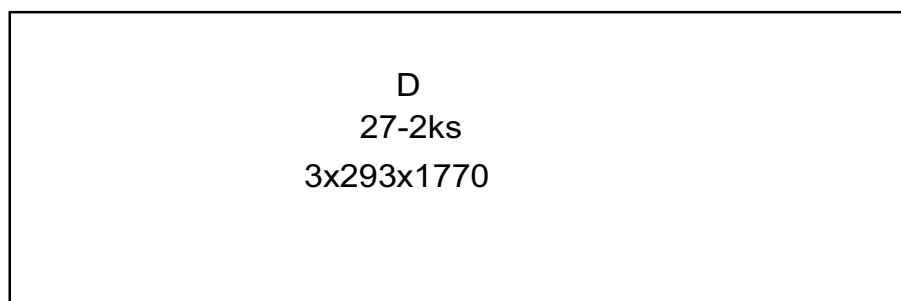
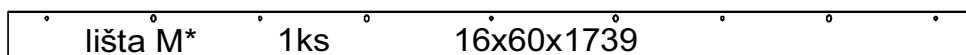
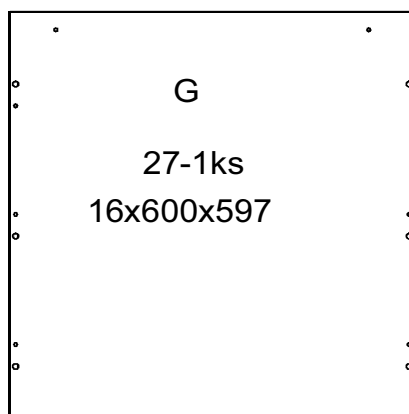
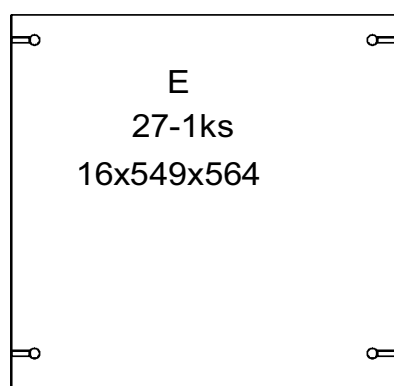
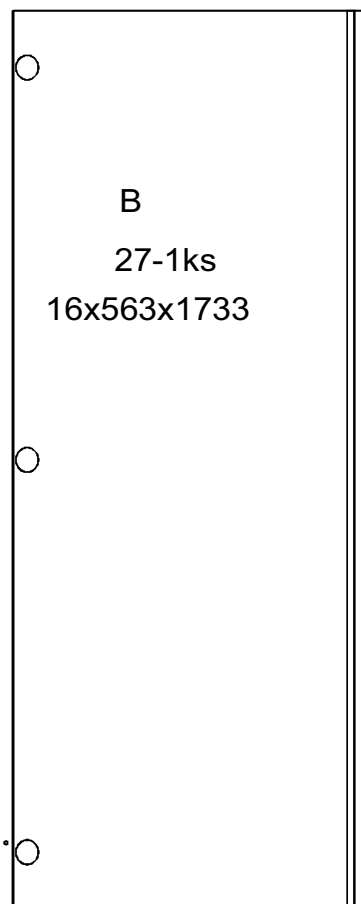
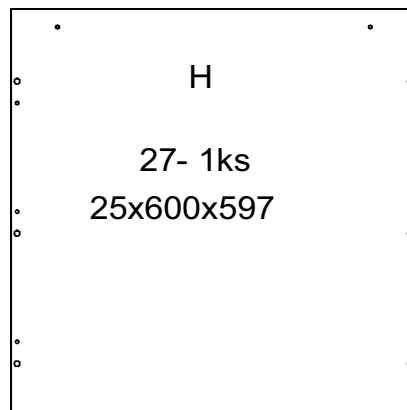
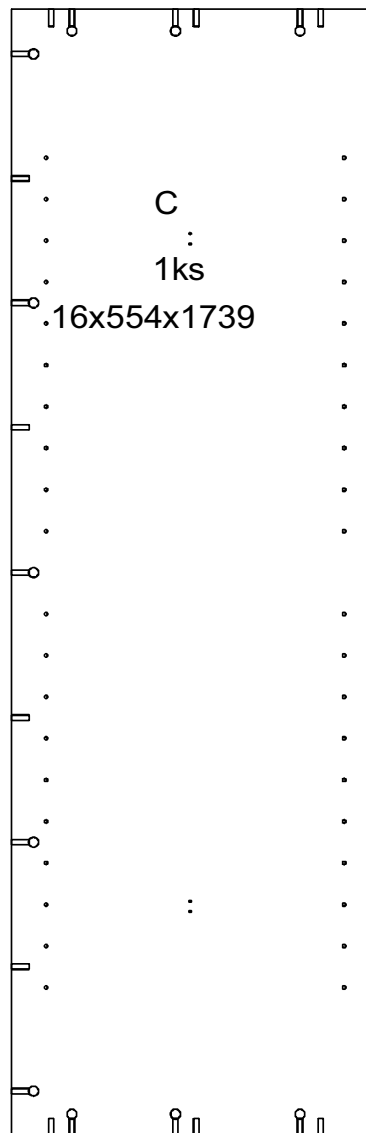
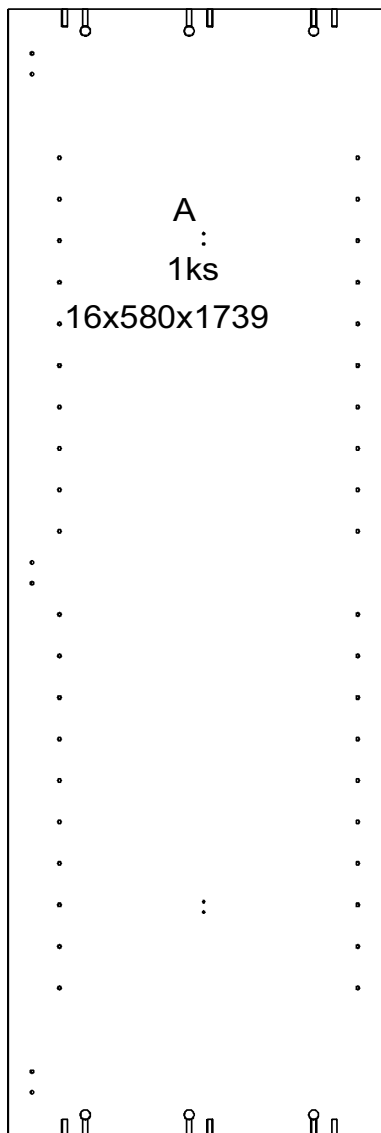

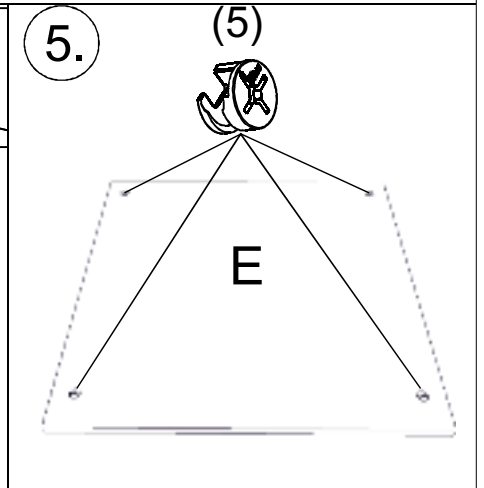
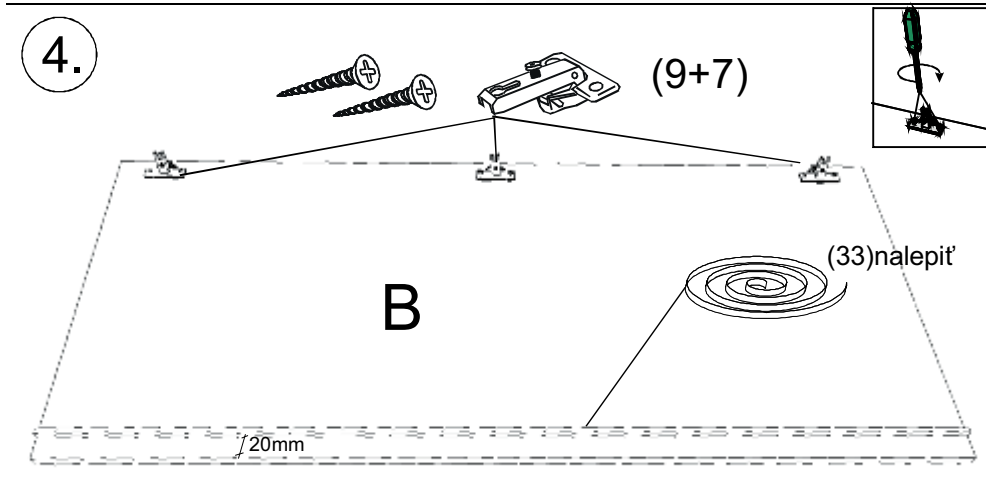
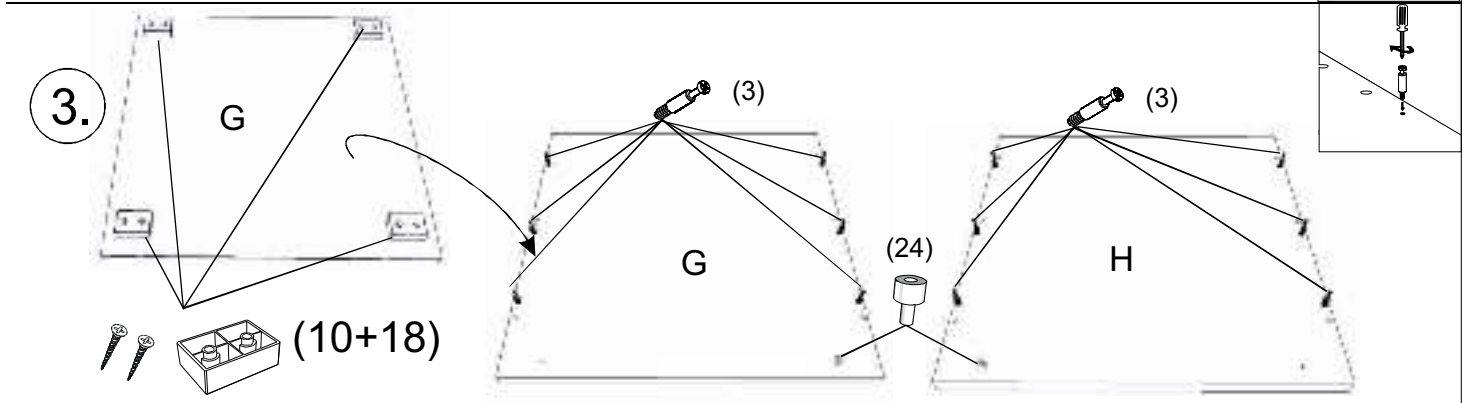
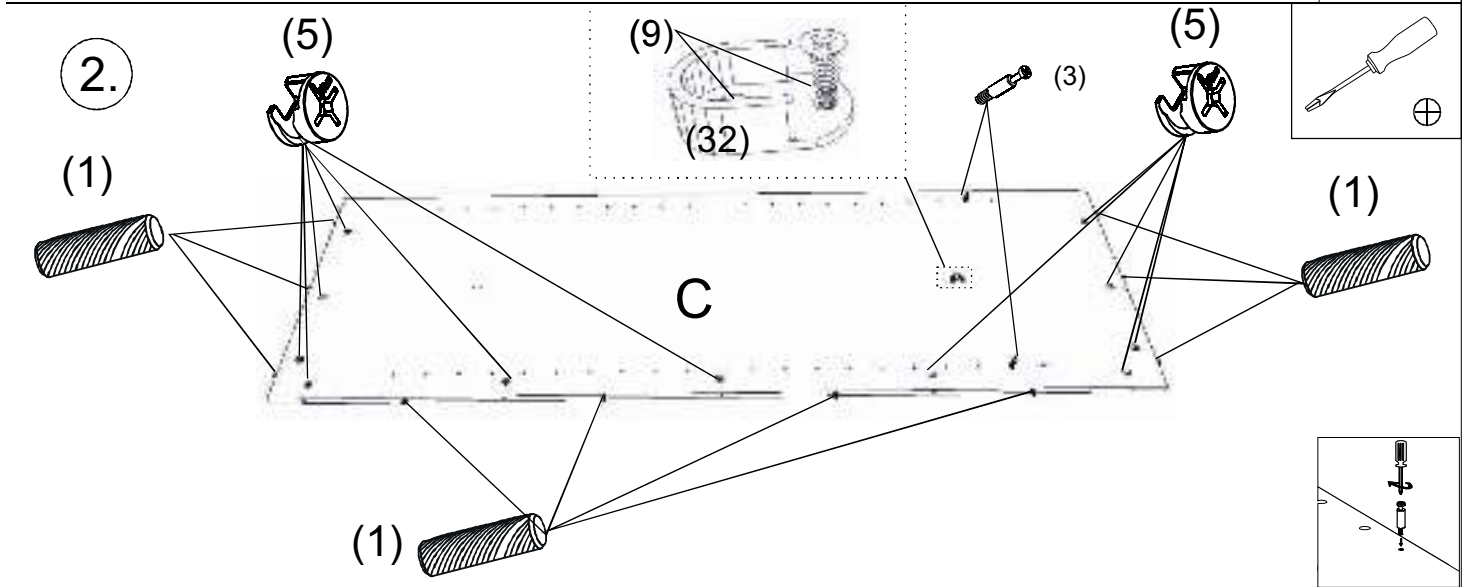
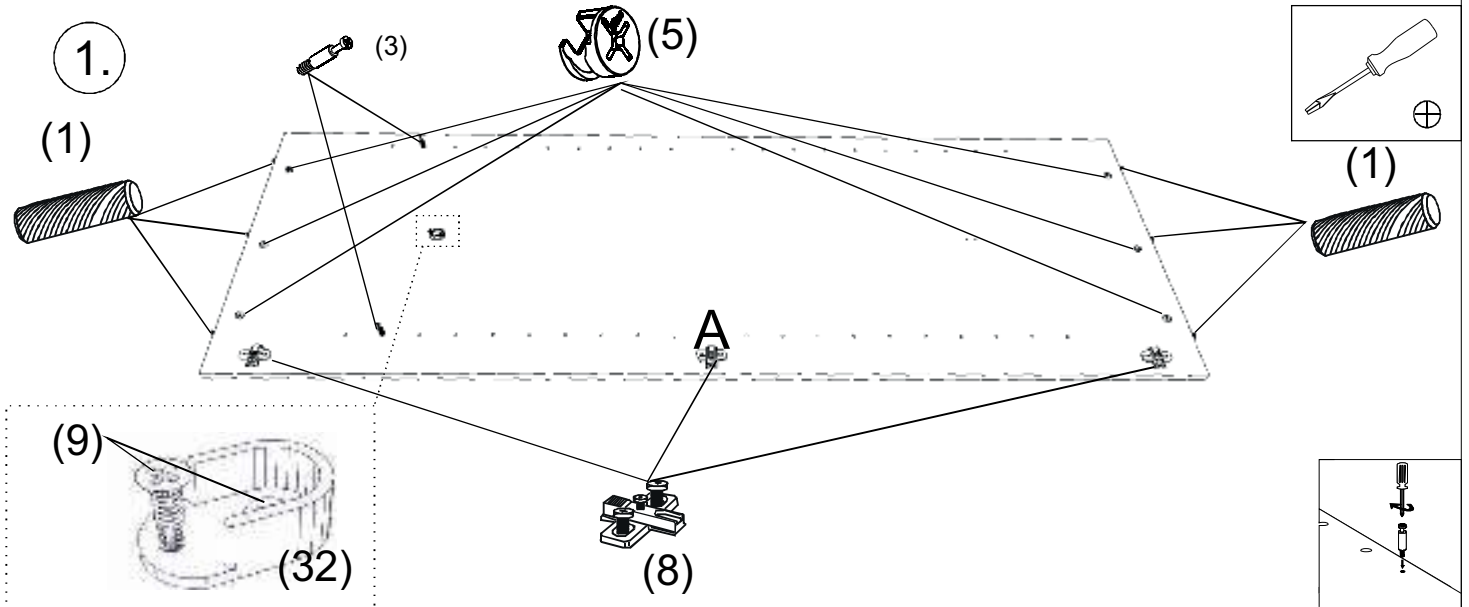

6.

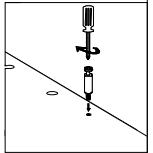
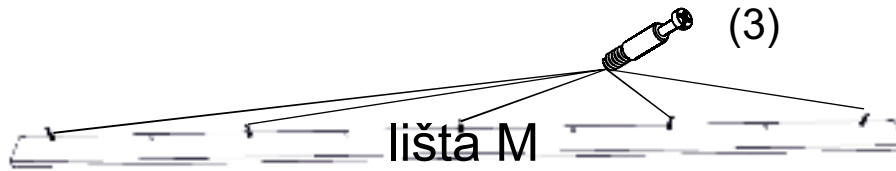

7.

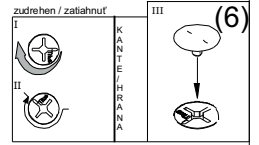
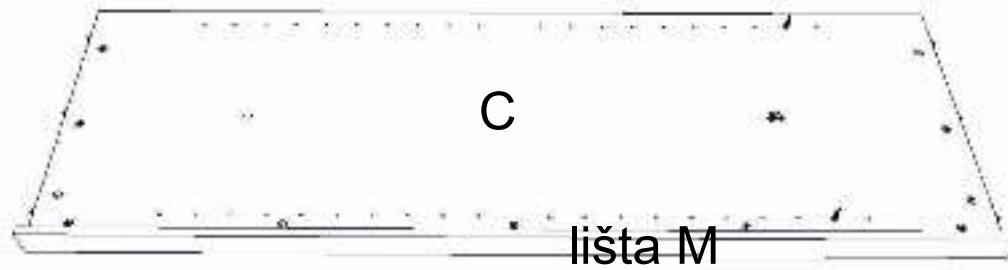

8.

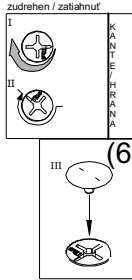
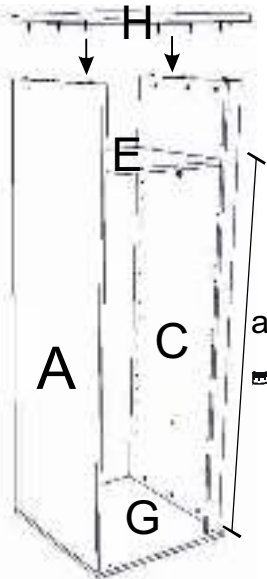

9.

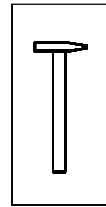
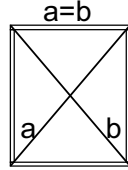
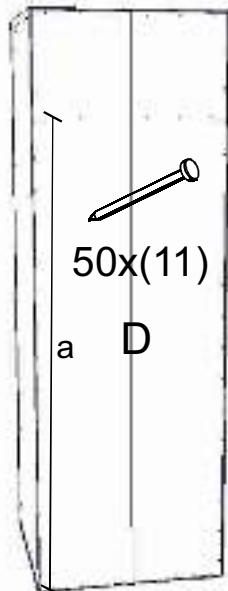

10.

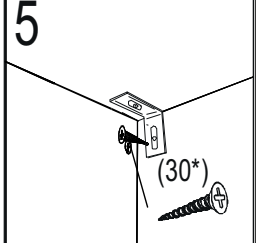
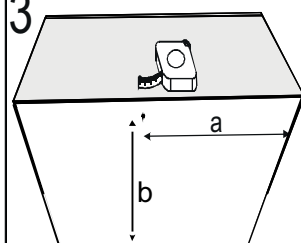
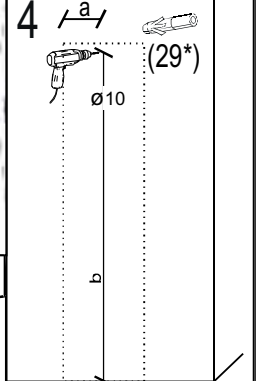
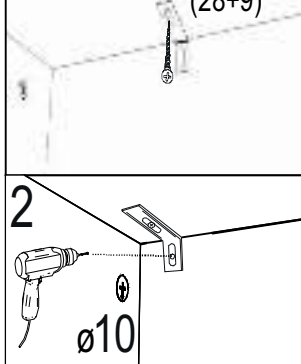

11.

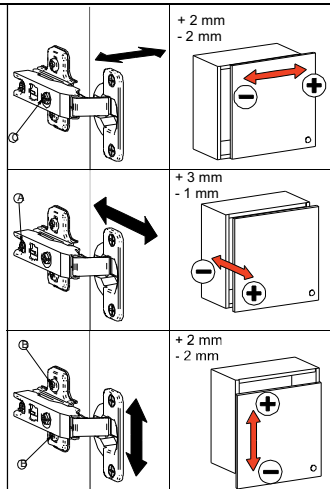
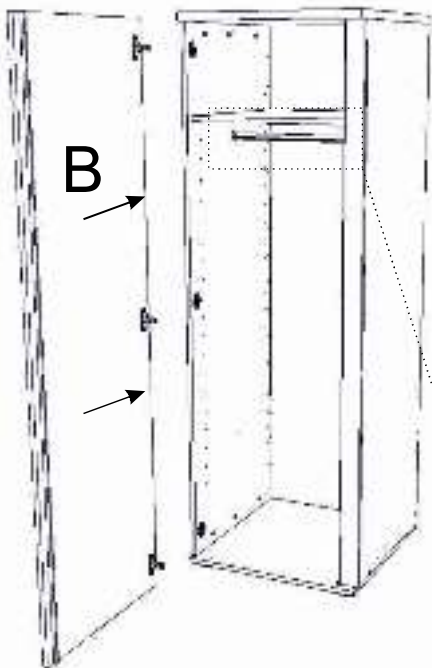

12.

