

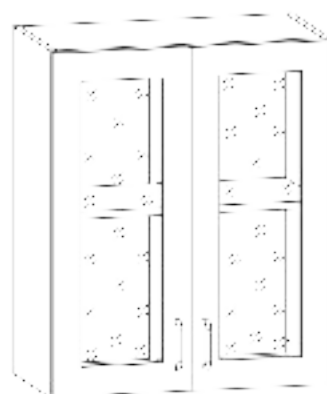

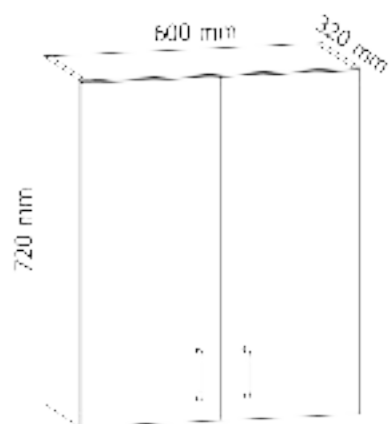

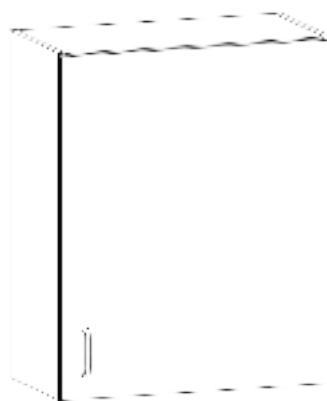

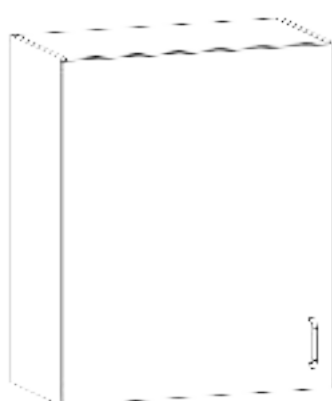



G60 / G60S

W60 / W60S

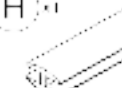
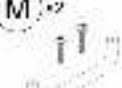

G60-L / G60-P

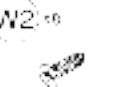
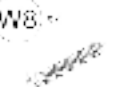
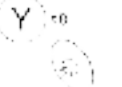

A ¹⁵  K6x25mm	B ¹⁵  K6x25mm	C ¹⁵  M 2x12mm	E ¹⁵ 
G ¹⁵ 	H ¹  7x2 mm	M ¹² 	N1 ¹² 
N2 ¹² 	W2 ¹⁶  K6x16	W8 ¹⁶  C6x8mm	Y ¹⁶  Ø 6 mm
Zc ¹⁵  2x1	 4x2		

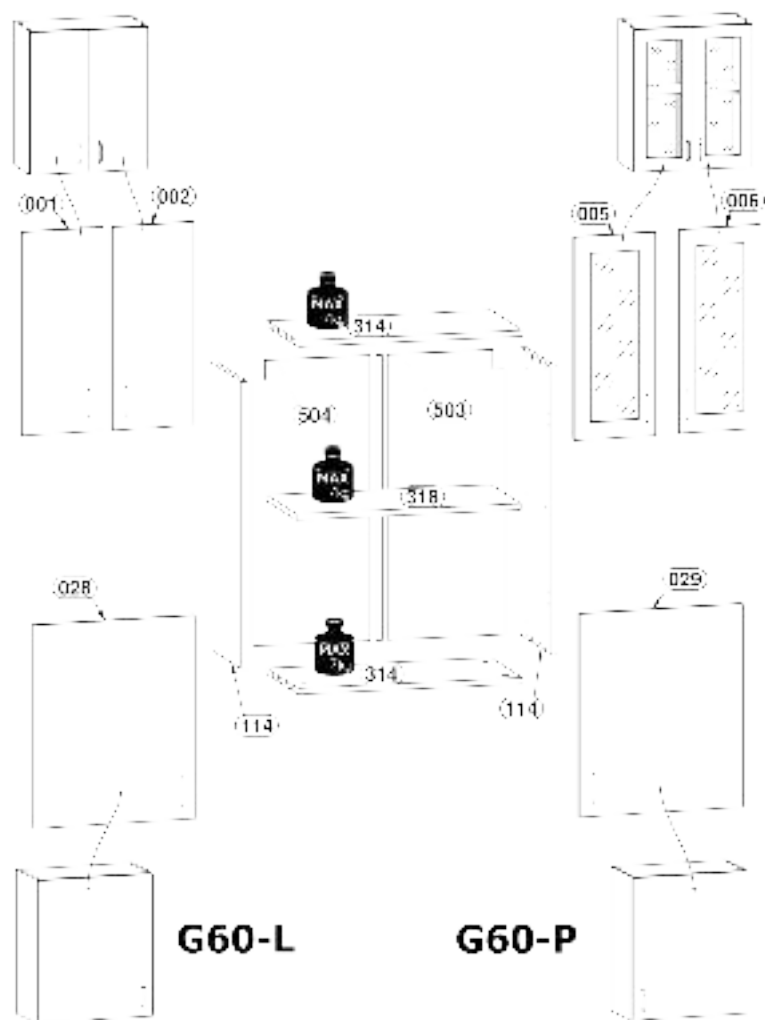

G60-L

G60-P

1

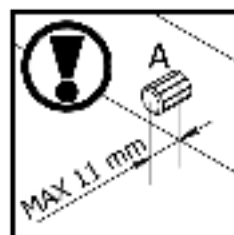
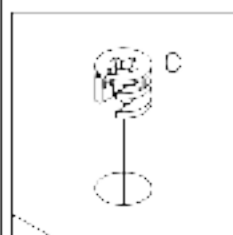
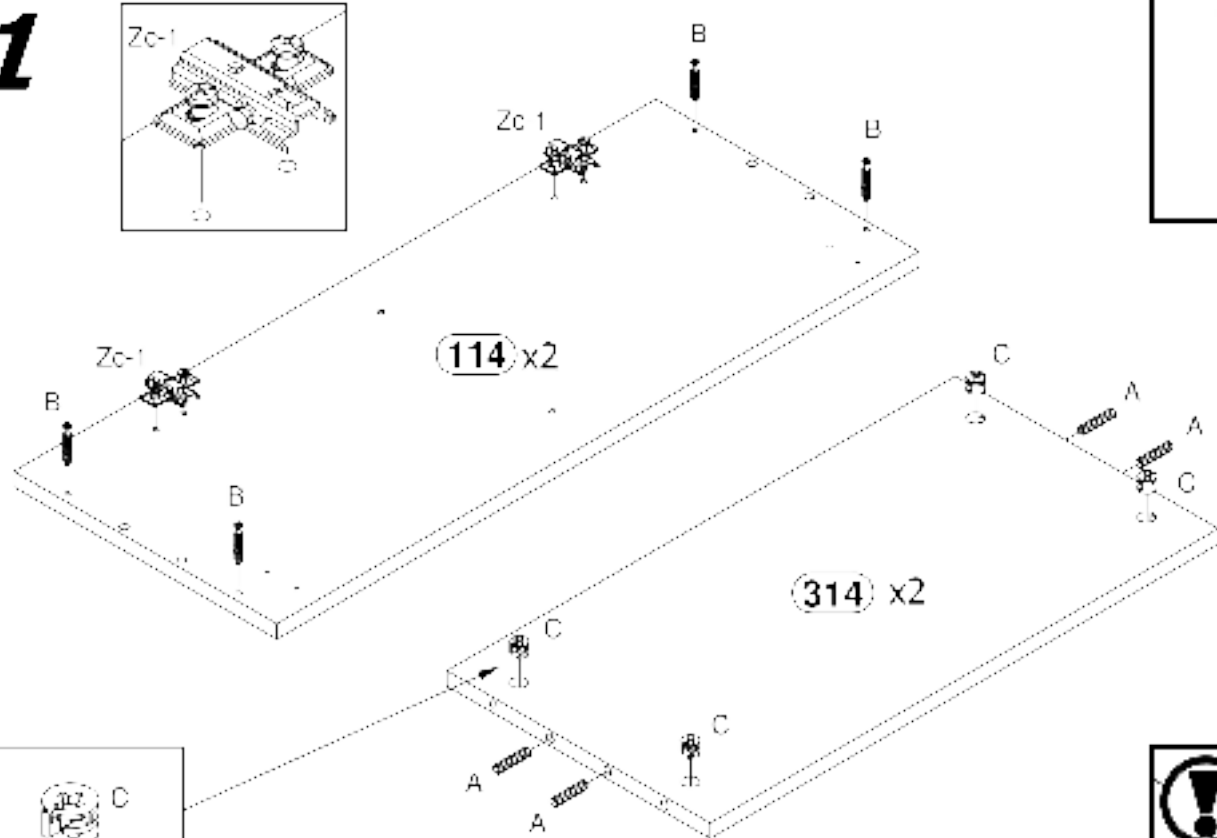
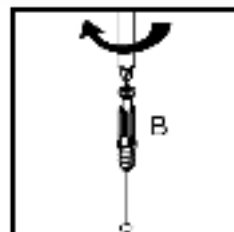
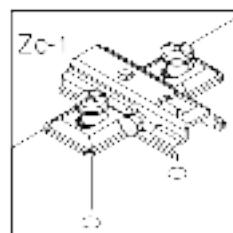

2

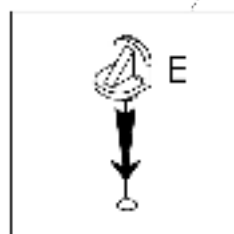
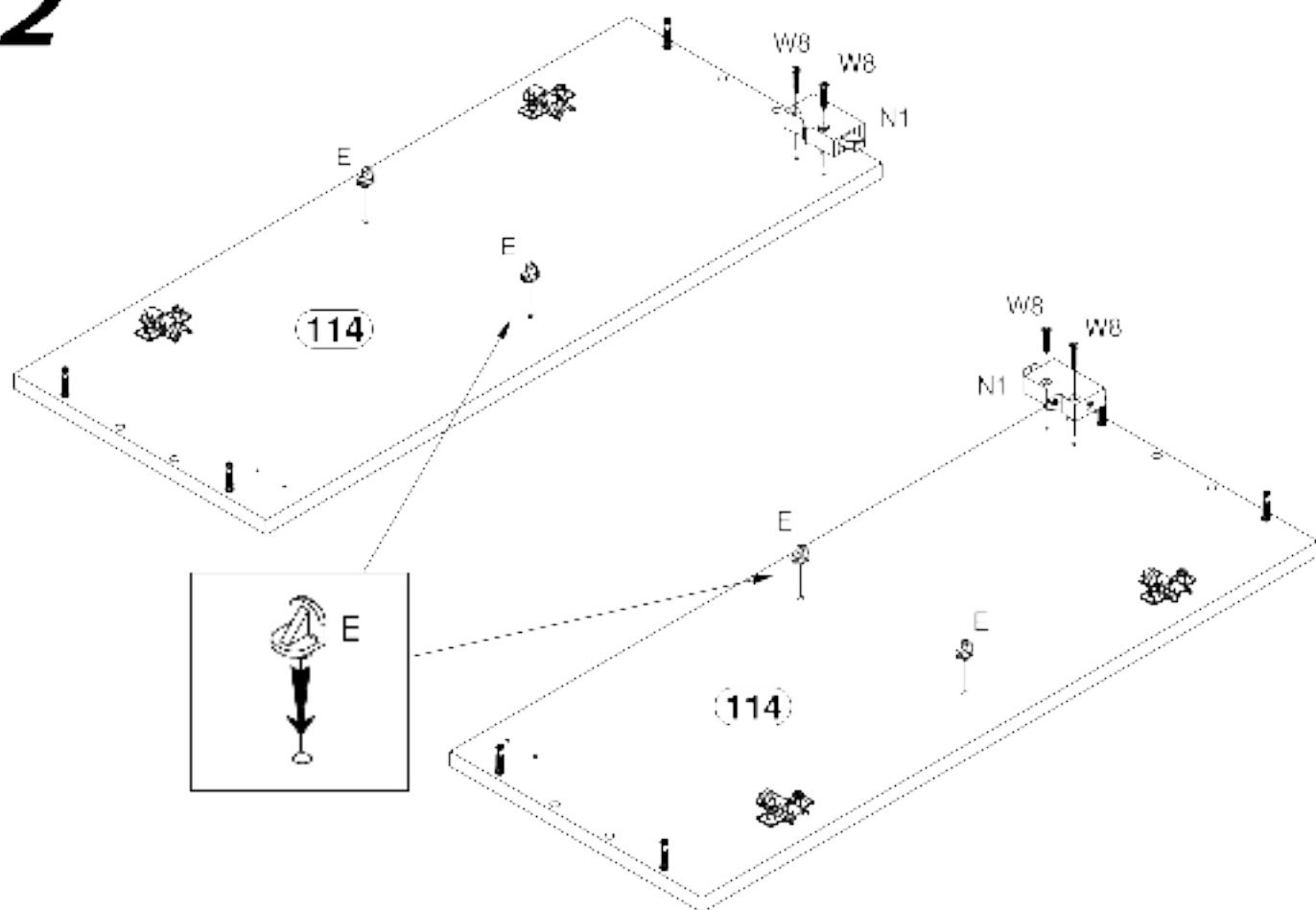

3

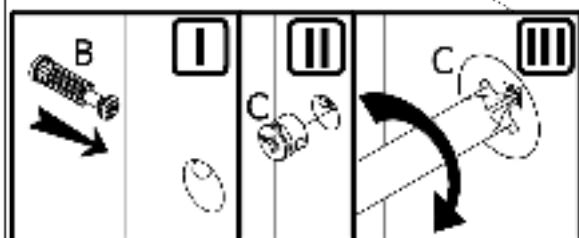
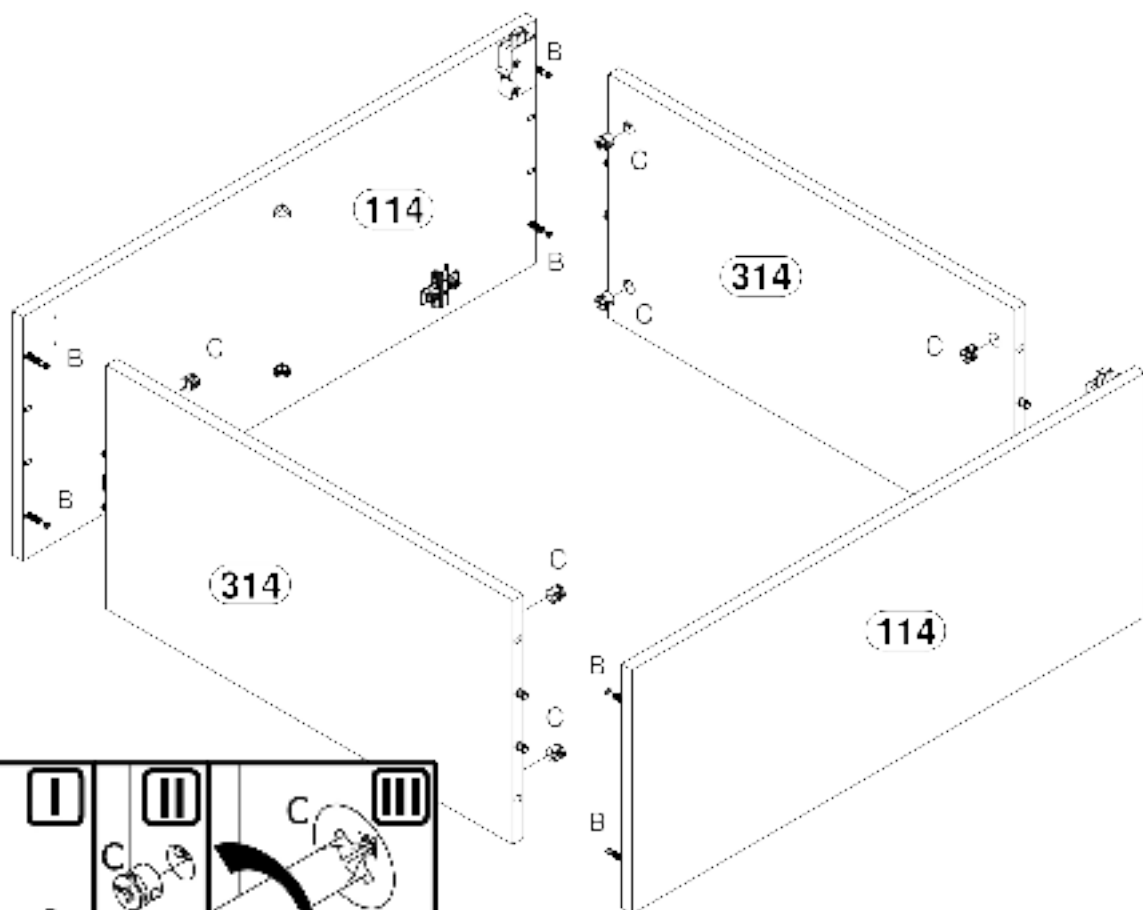

4

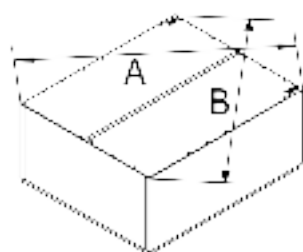
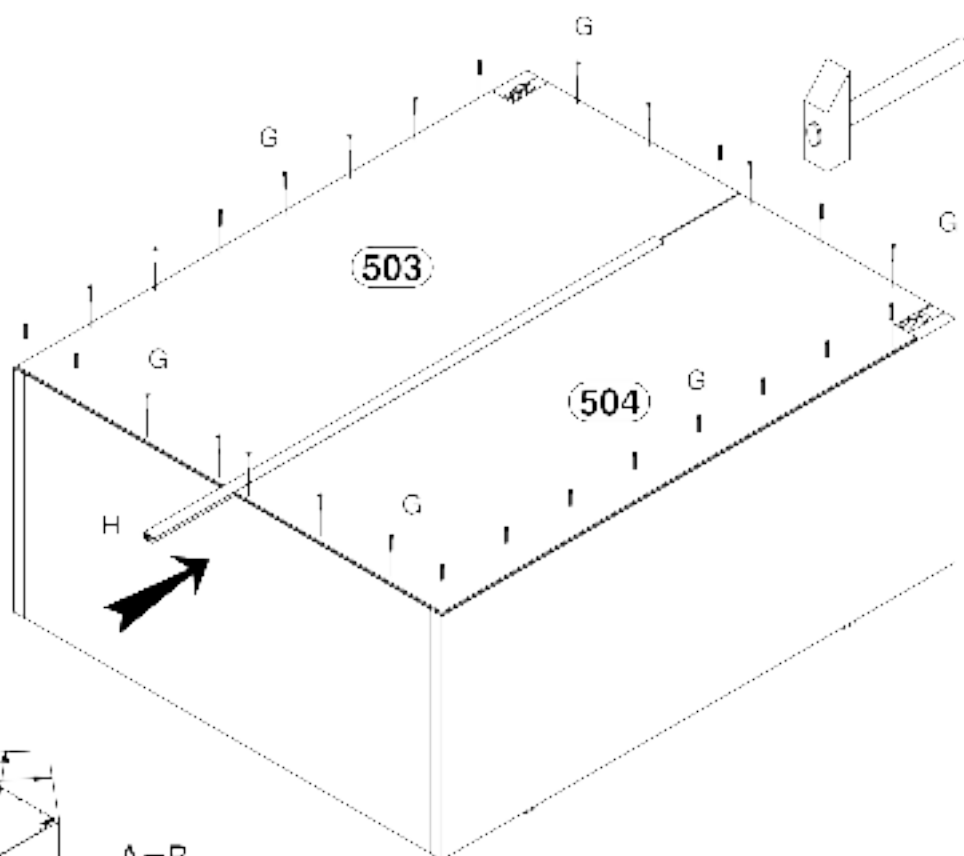

A=B

5

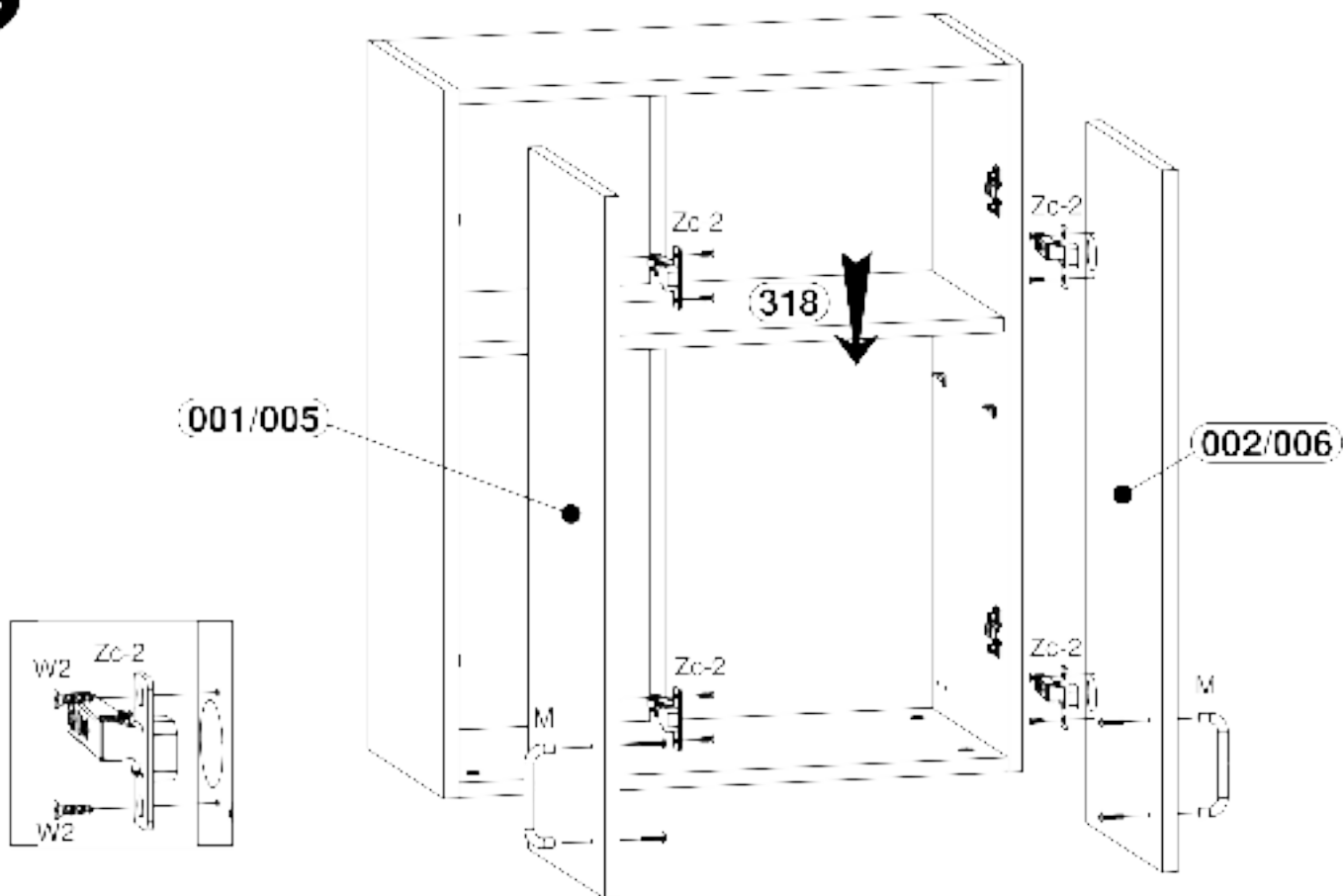

6

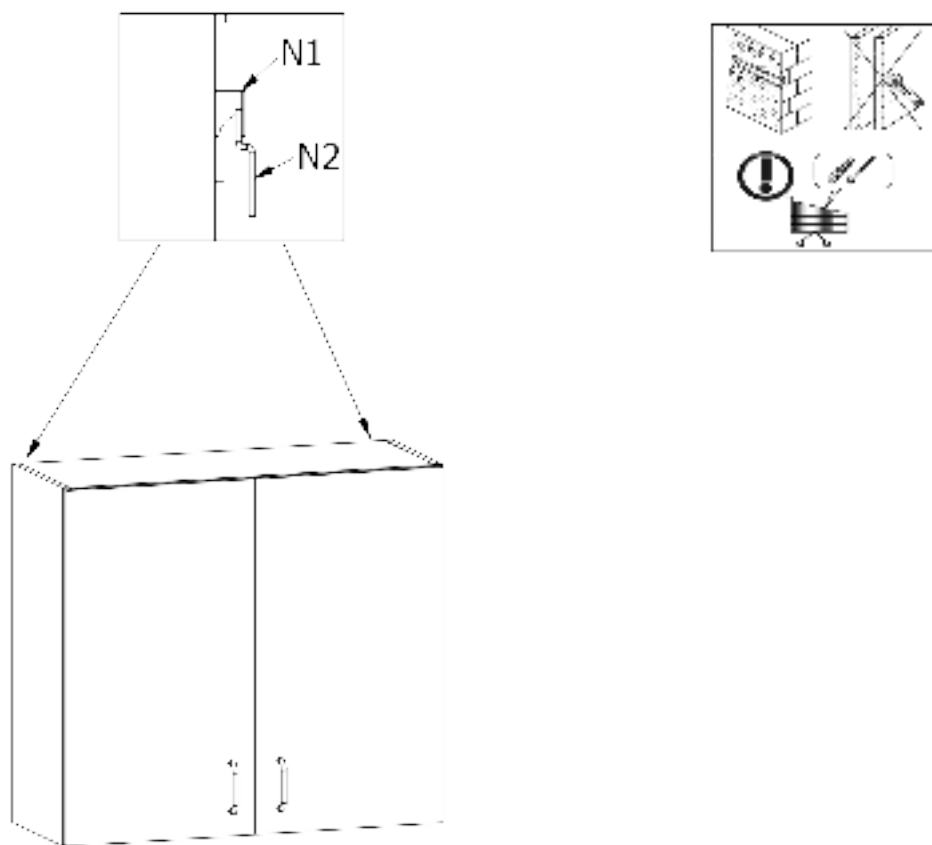

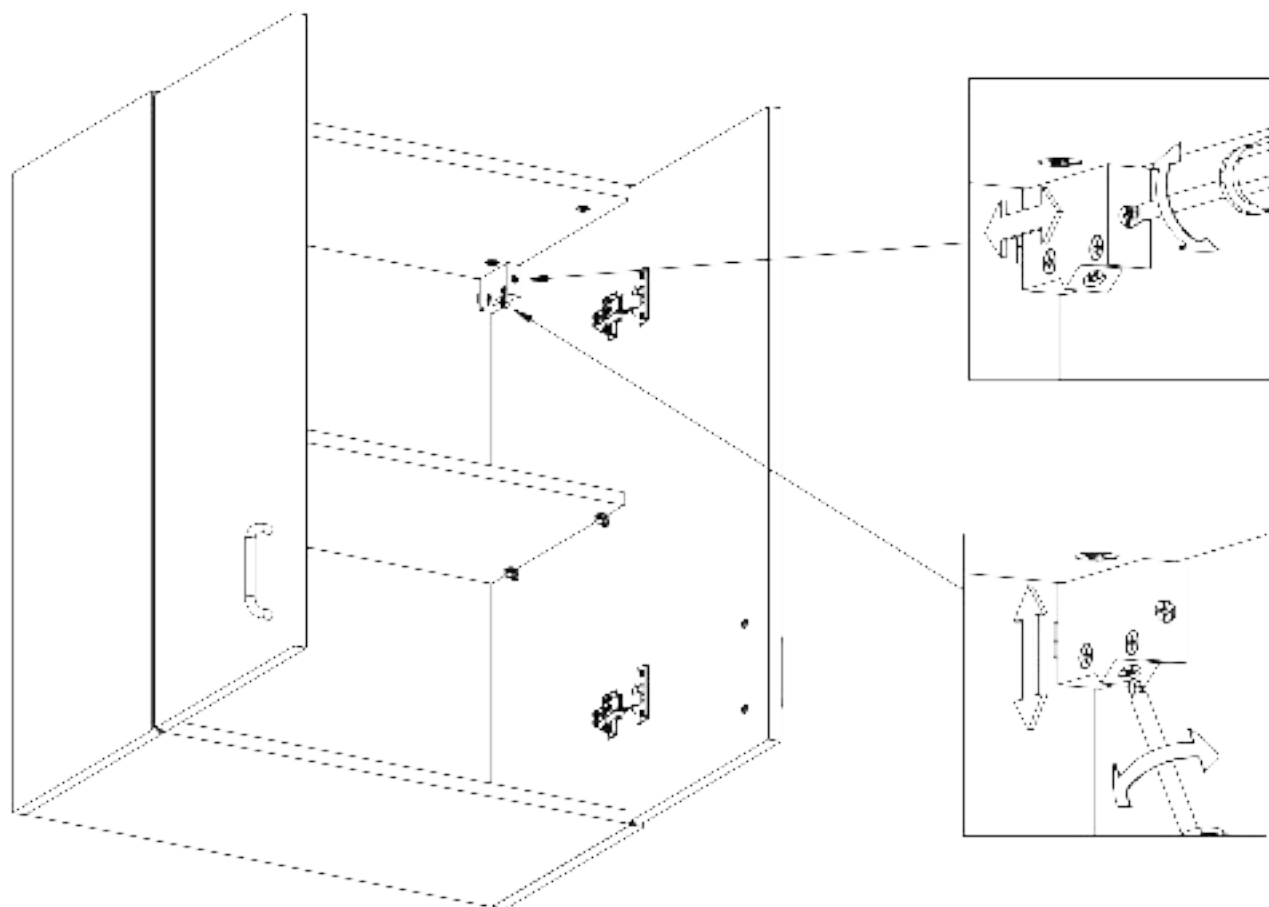
7**8**