

**DREVONA®**  
N Á B Y T O K

REA HOUSTON 1  
**SKR-HT01**  
1500-645-2000

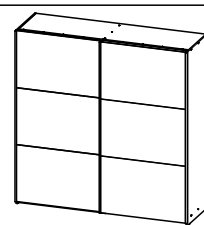

A 18x	B 32x	C 4x	D 32x	E 14x	F 8x	G 8x	H 2x	J 2x	K 6x
L 2x	M 2x	N 2x	O 2x	P 2x	R 2x	S 1x	T 1x	U 3x	V 1x
Y 1x	Z 7x	AA 80x	AB 23x	AC 4x	AD 2x	AE 2x	AF 102x		

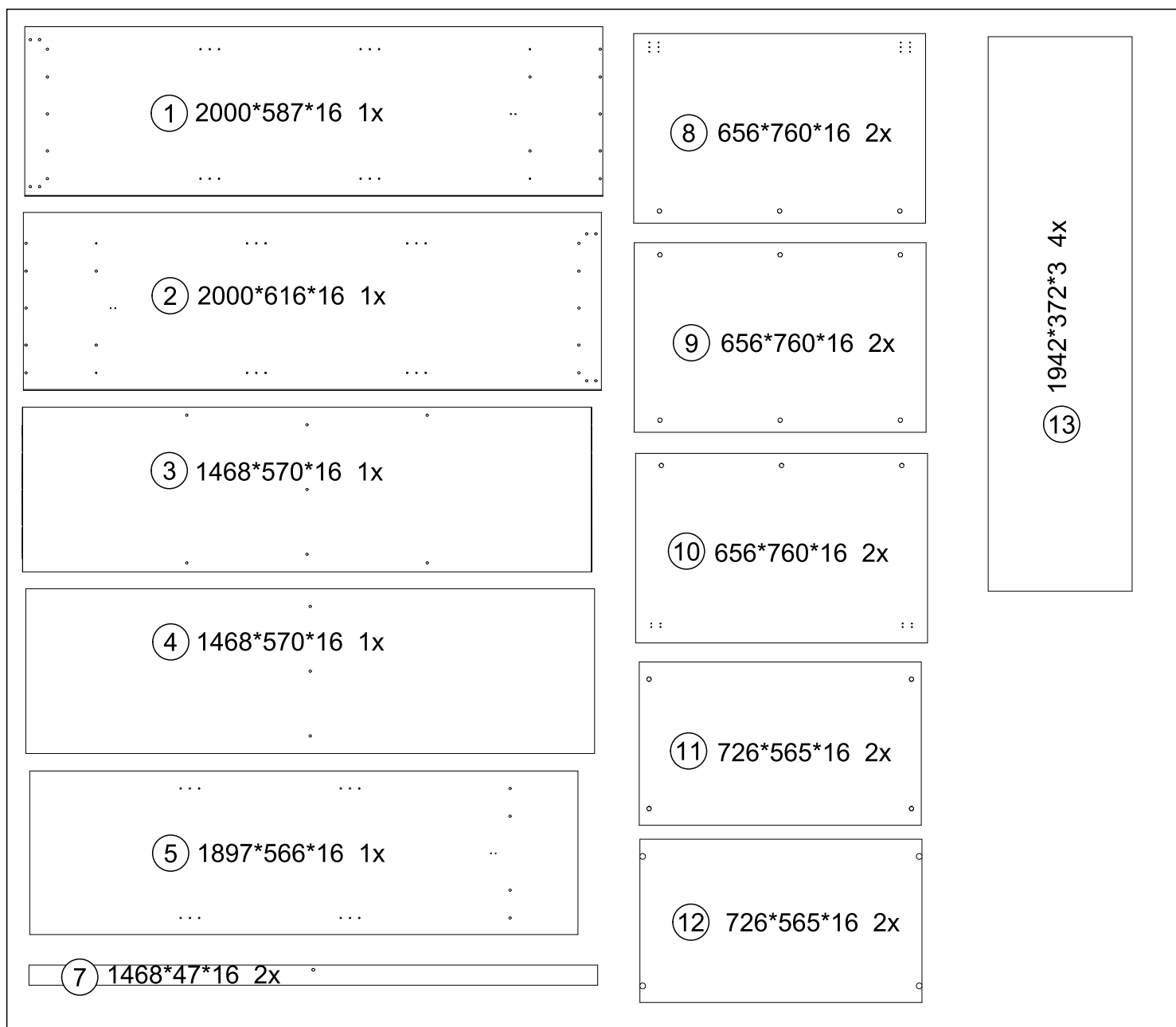

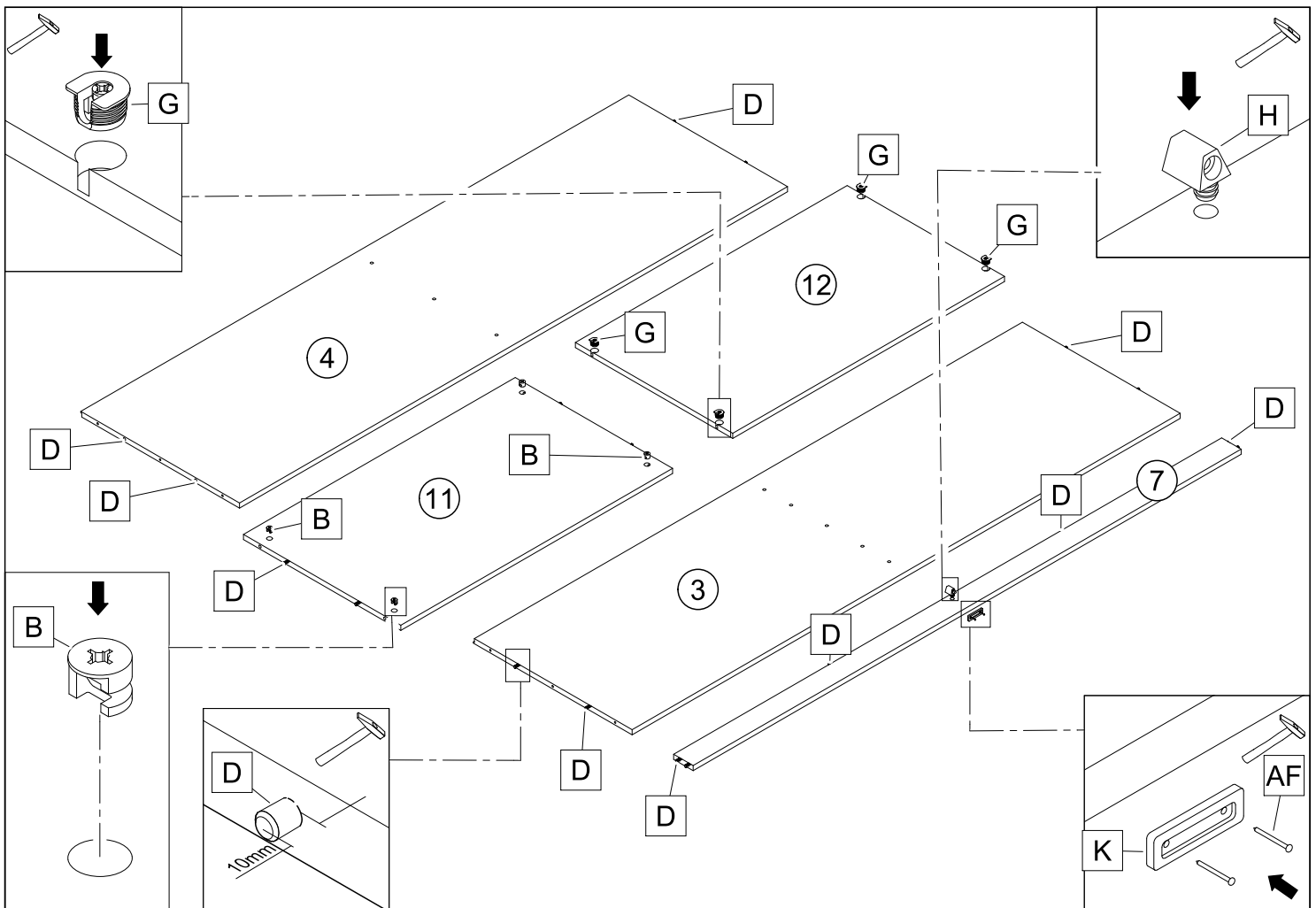
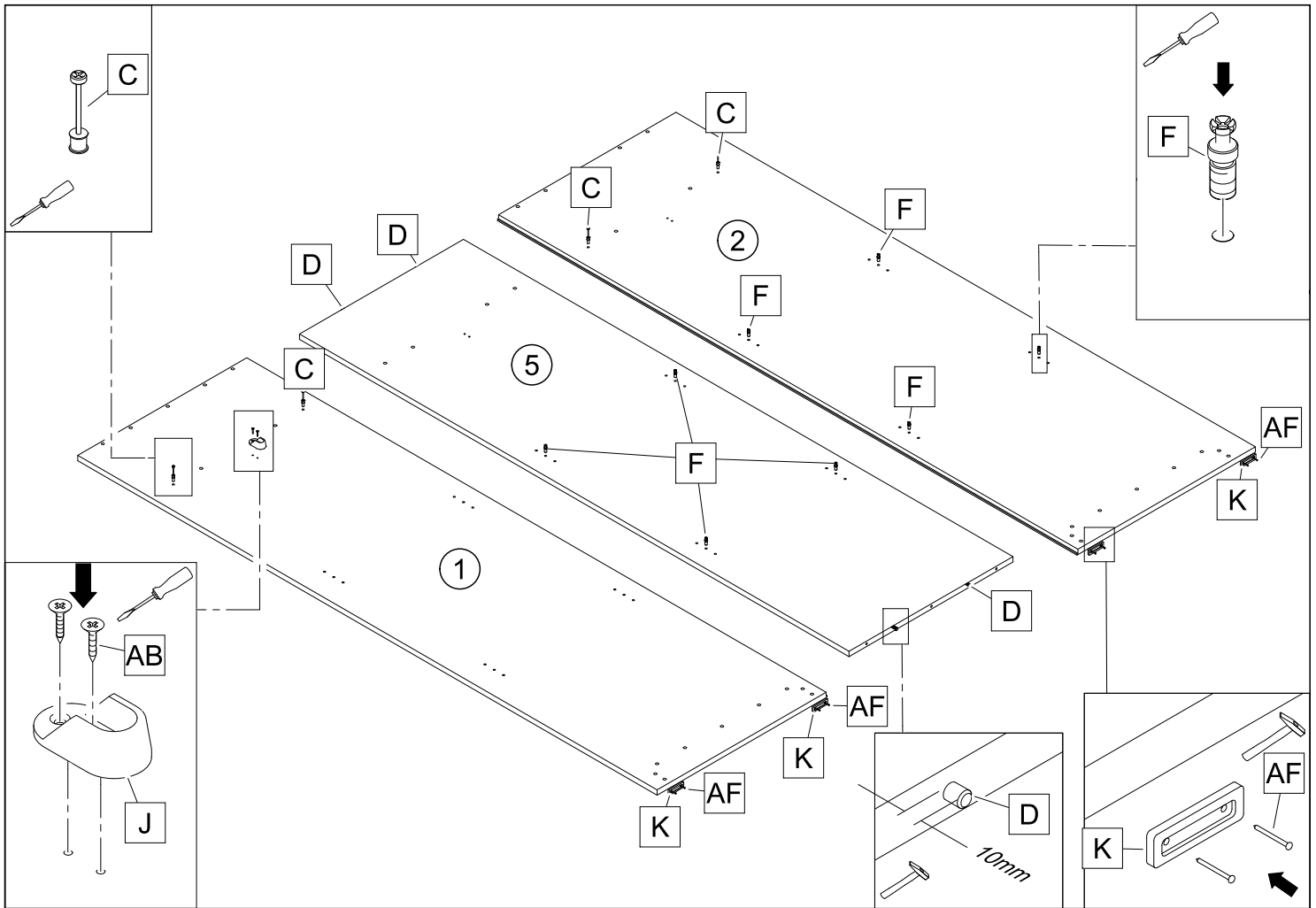

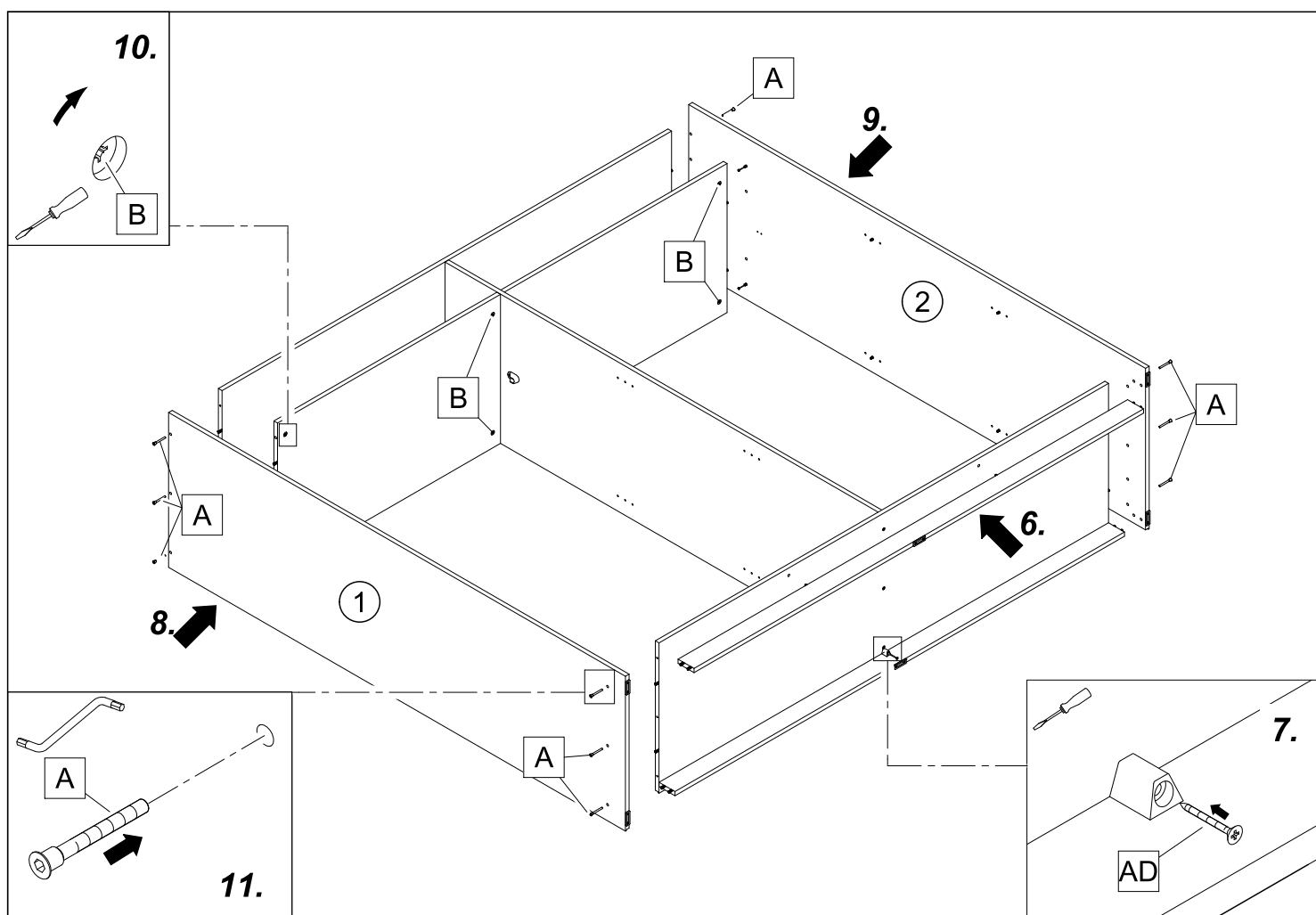
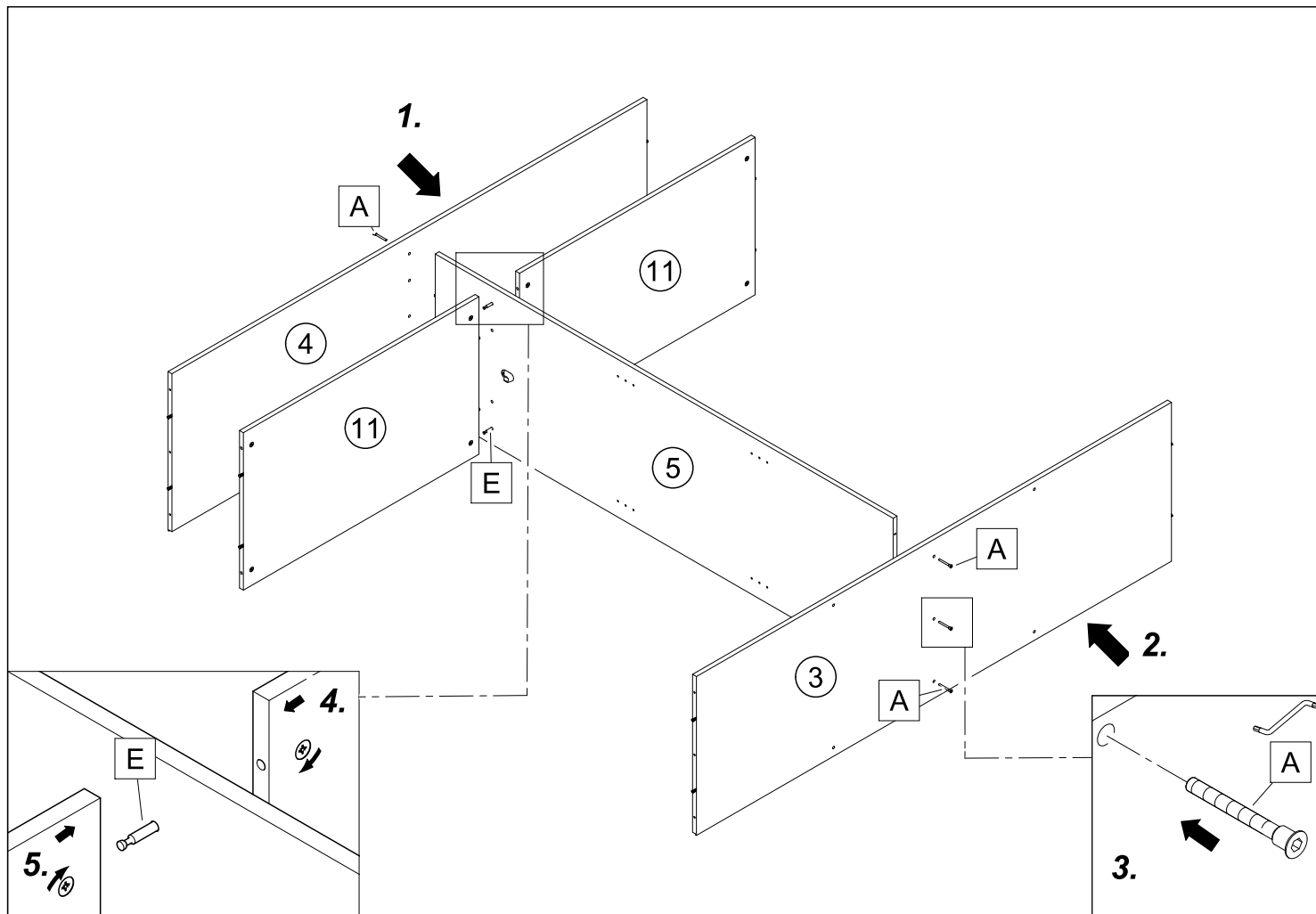

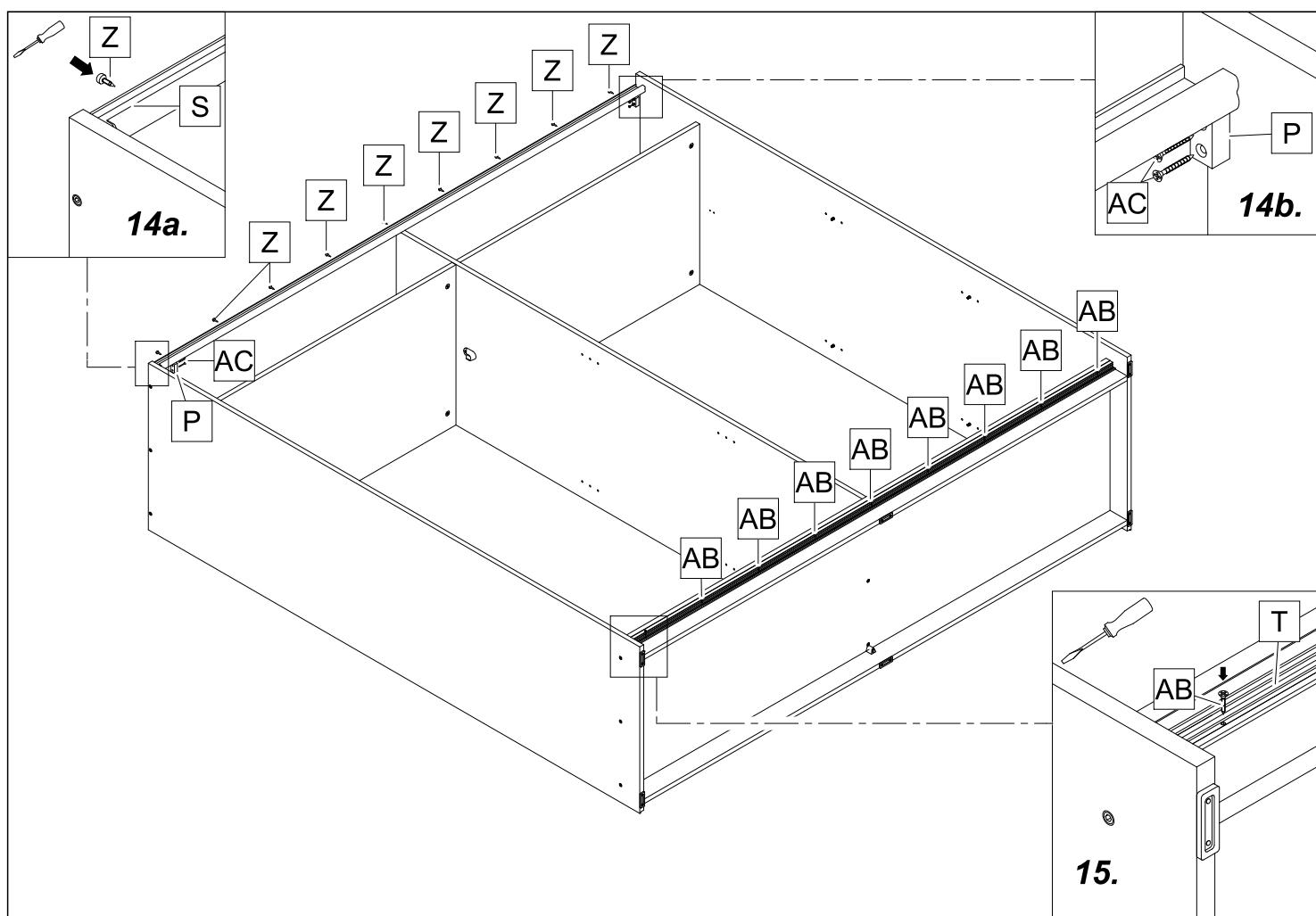
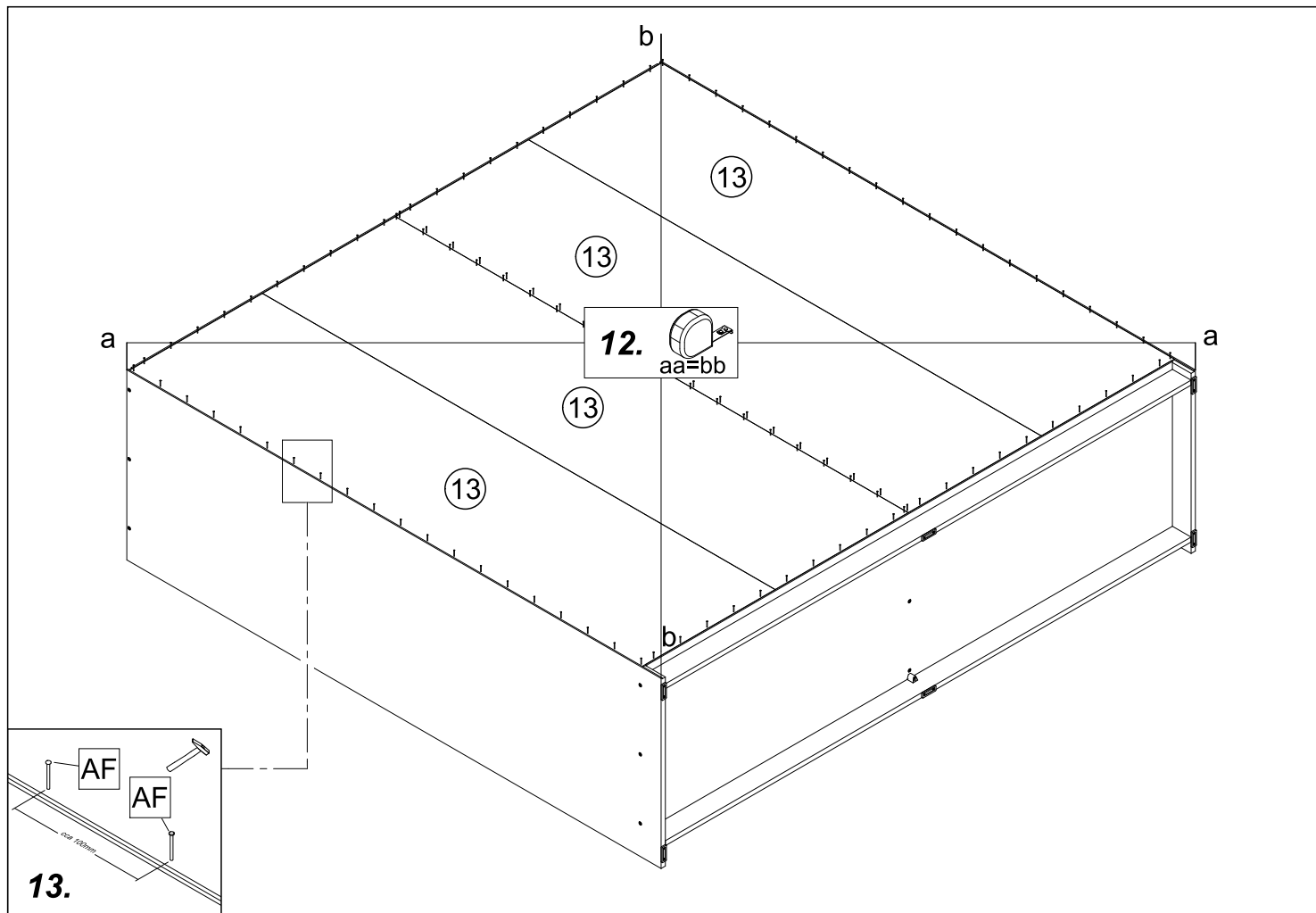



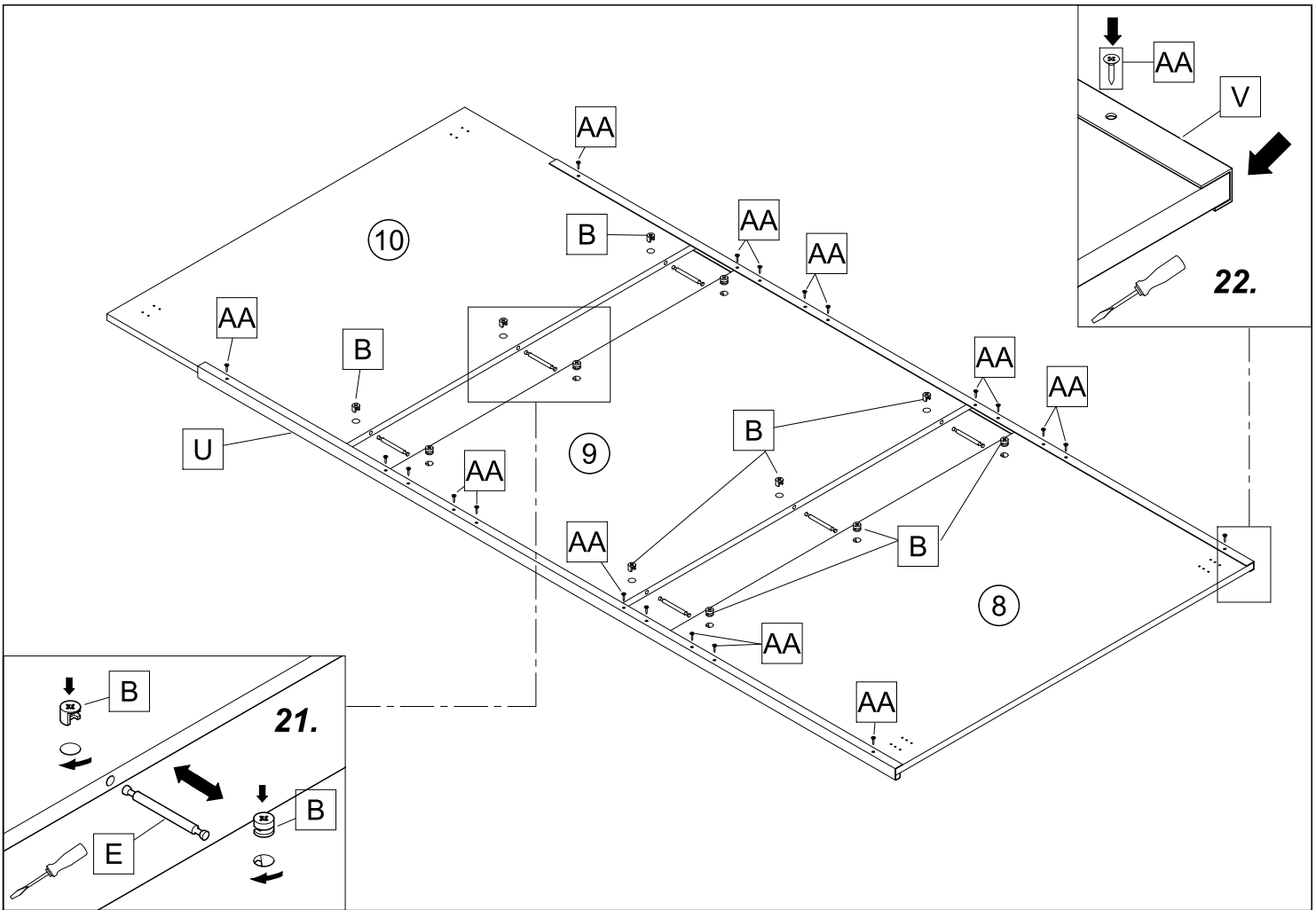

23. →

