

LANGEN

G40

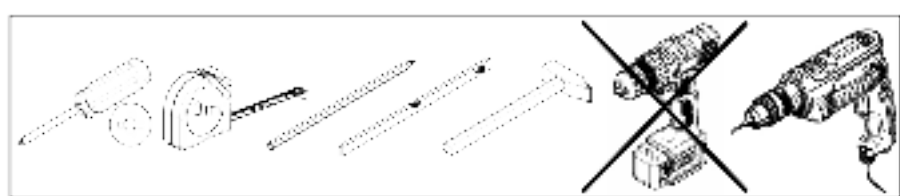

A1 x8 Ø8x35mm	B1 x8 Ø5x38mm	C1 x8 Ø15x17mm	E1 x4 Ø5x16mm	G1 x22 26mm
I20 x1 63x21x11mm	J10 x8 Ø21mm	O1 x2 70x39x18mm	O5 x2 76x32x6mm	U18 x1 200mm
W2 x6 Ø3.5x16mm	W5 x6 Ø4x30mm	Y1 x2 Ø5x15mm	Z1 x2 97x40, H=2	Z3 x2 Ø55, 7K1

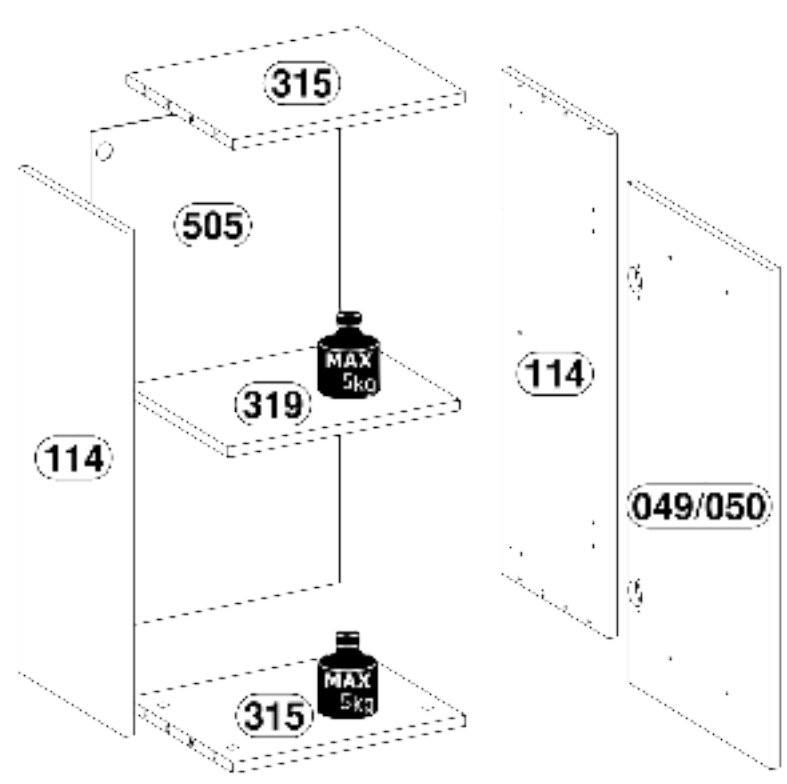
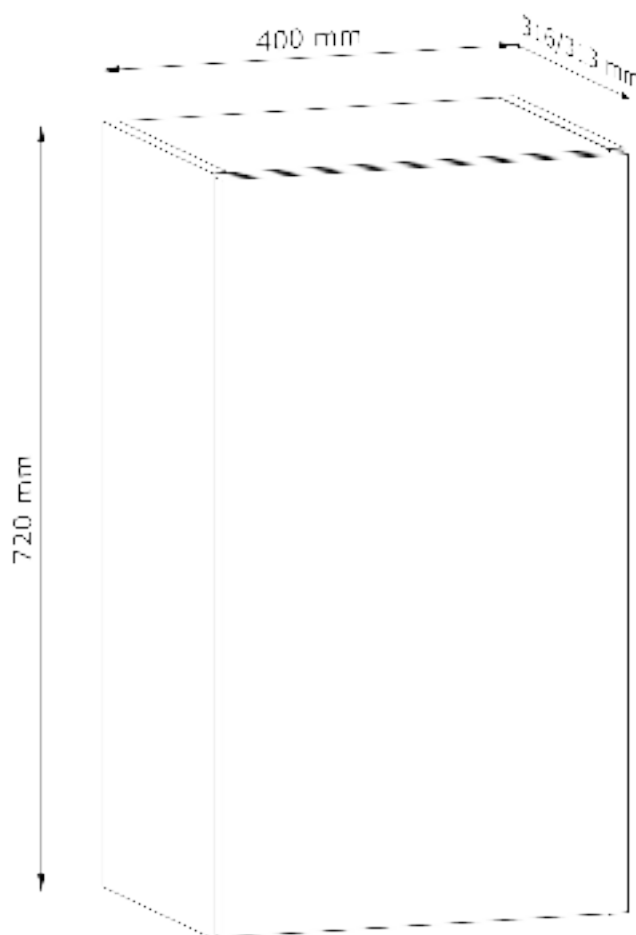

Nr.	Lmm	W(mm)	H(mm)	PCS	BOX
049/050	413	399	15/18	1	2/2
114	720	285	15	2	1/2
315	305	870	15	2	1/2
319	290	970	15	1	1/2
505	715	887	2,6	1	1/2

1

B1 x 8



Ø5x38mm

O1 x 2



7Cx39x10mm

W5 x 4



Ø4x30mm

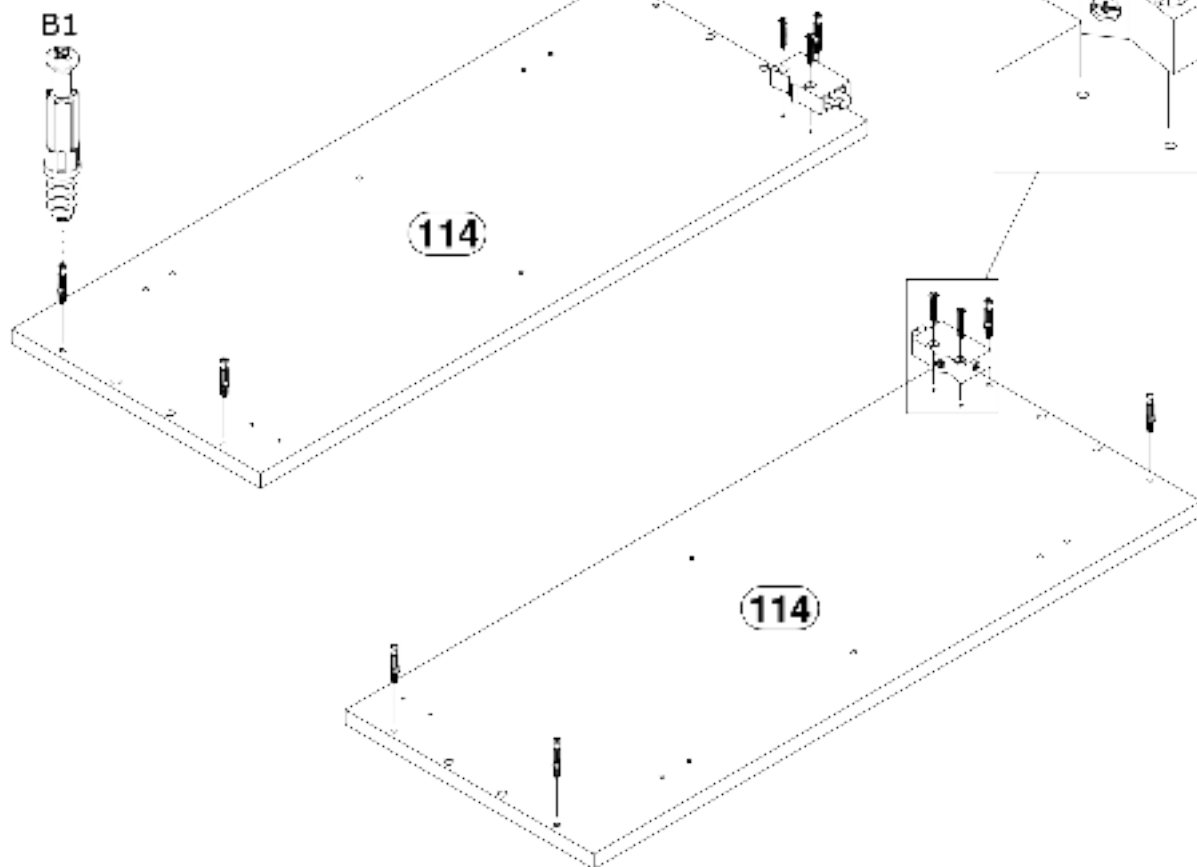
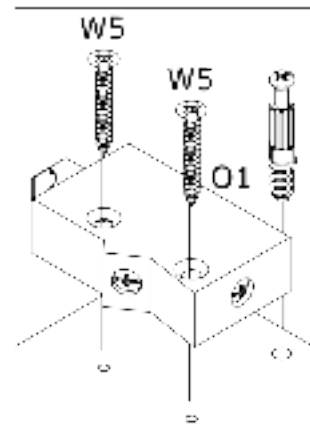
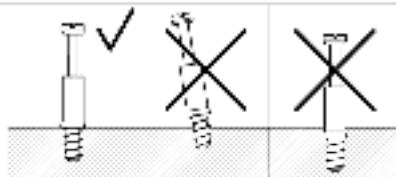
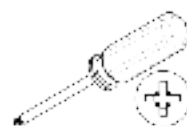

2

A1 x 8



Ø8x35mm

C1 x 8



Ø15x12mm

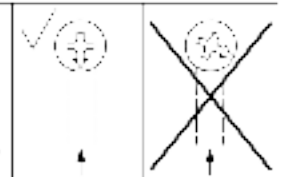
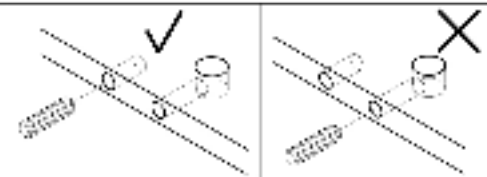
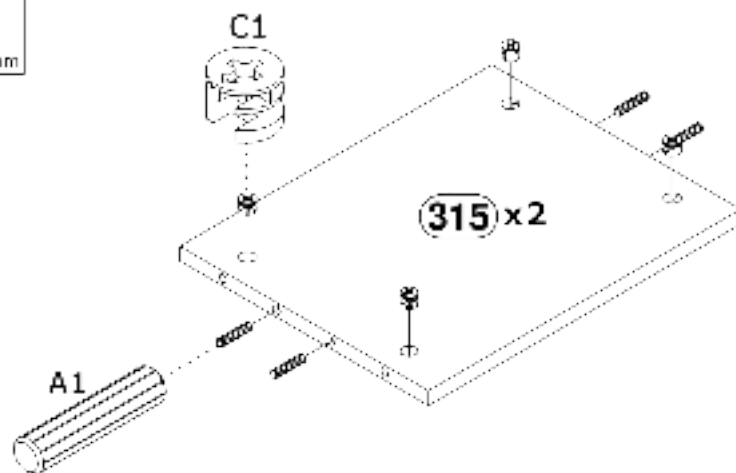
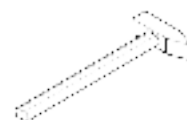

3

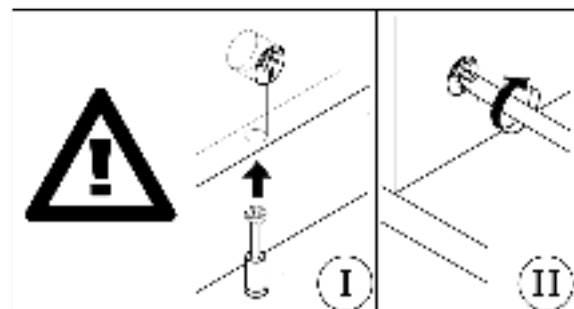
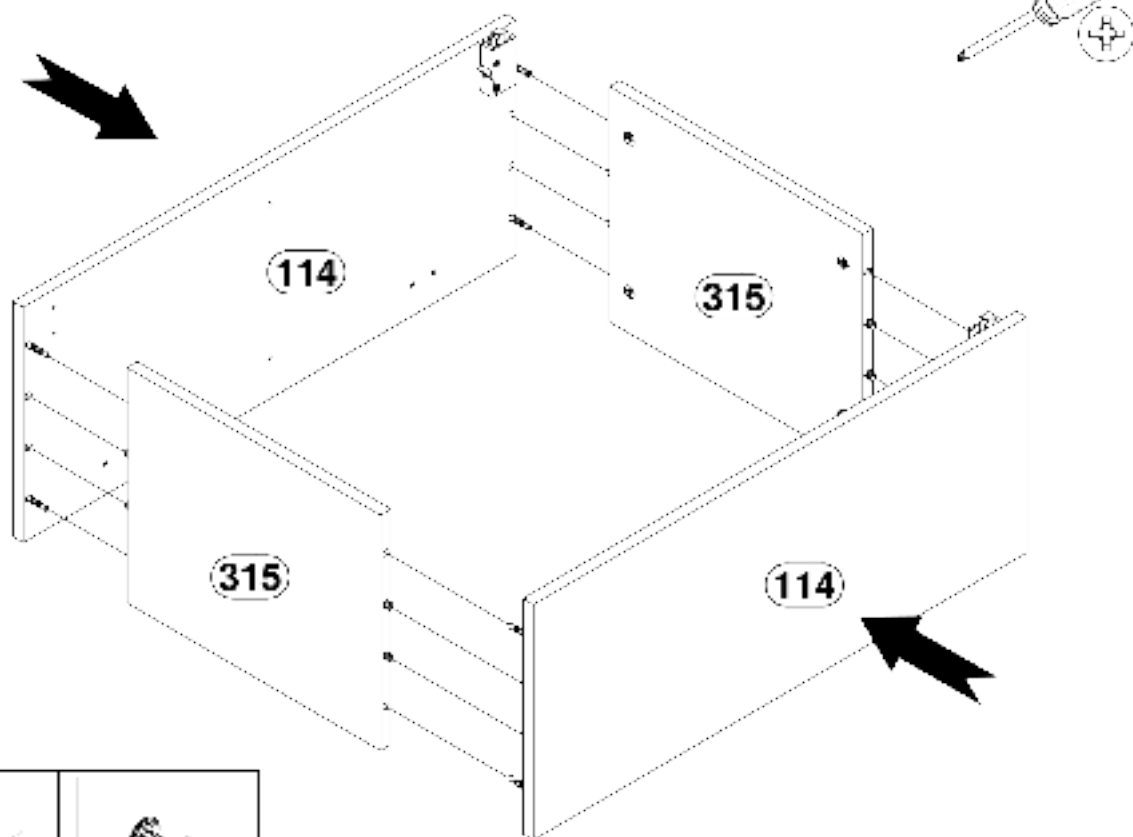

4

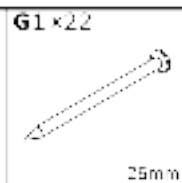

$A=B \equiv 90^\circ$

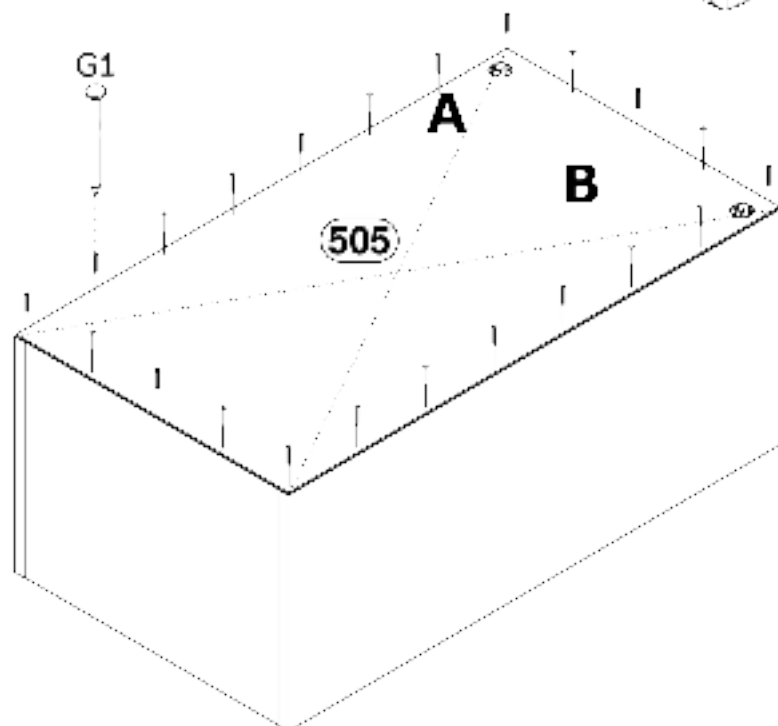
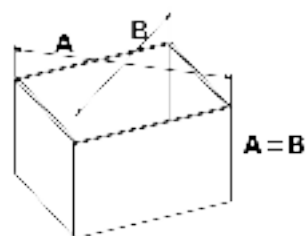

5

E1 x4



Ø5x16mm

J10x8



Ø21mm

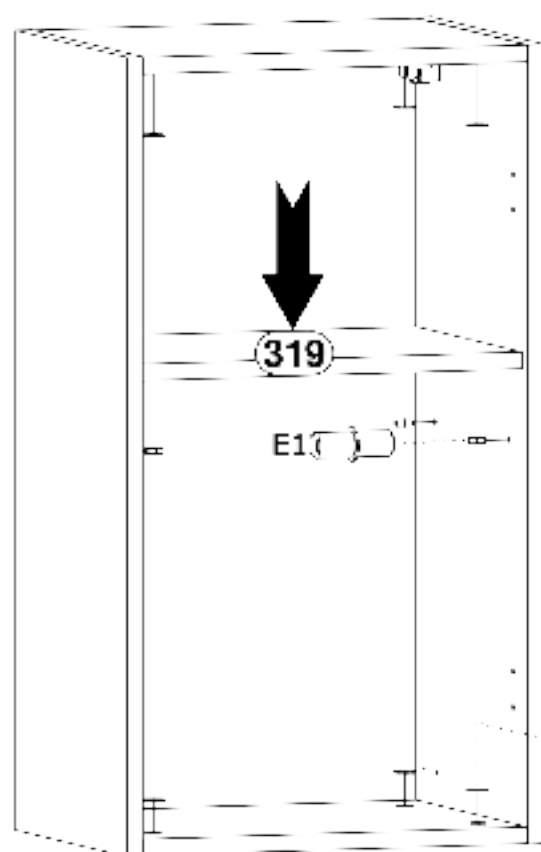
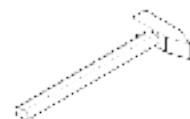

6

W2 x4



Ø3,5x15mm

Z3 x2



Ø86,2x80

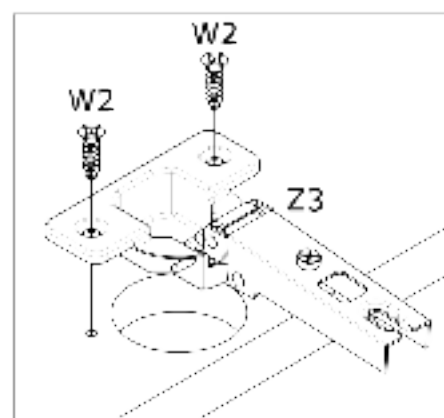
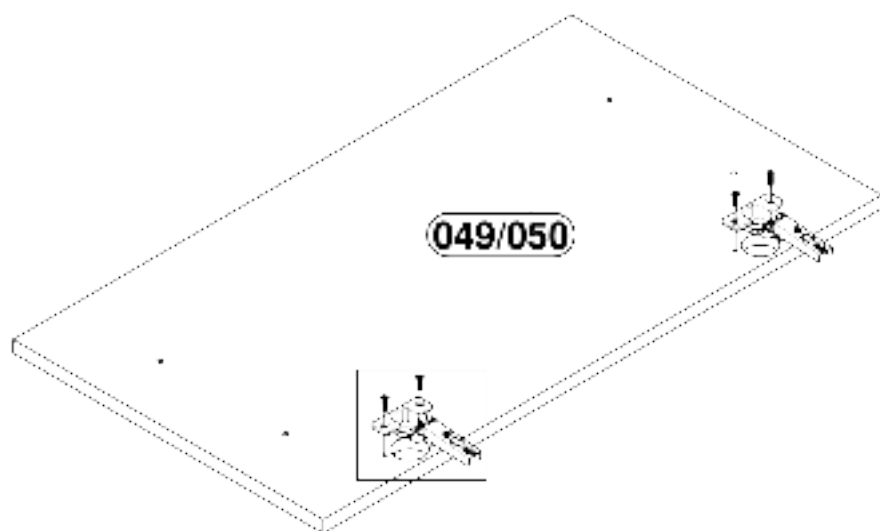

7

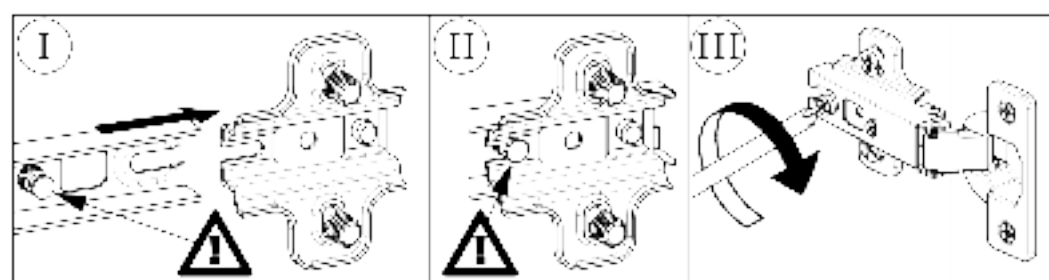
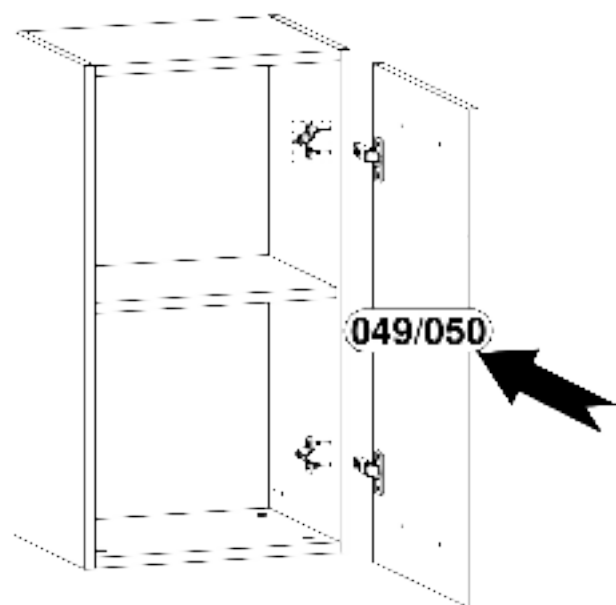
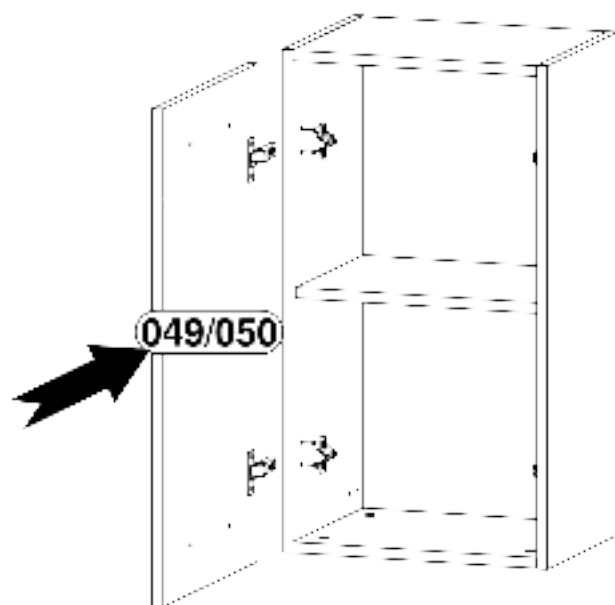
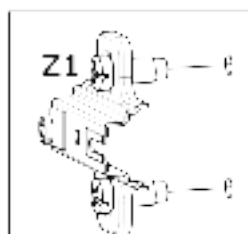
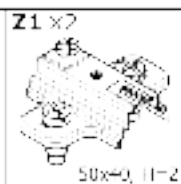

8

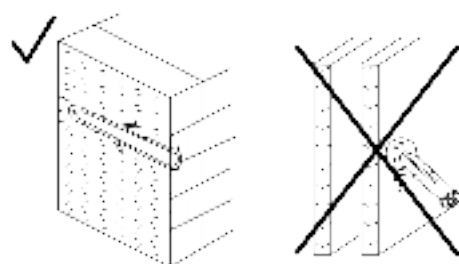
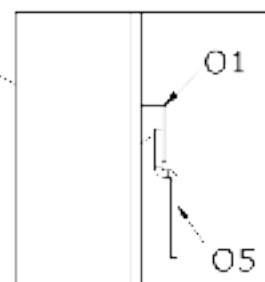
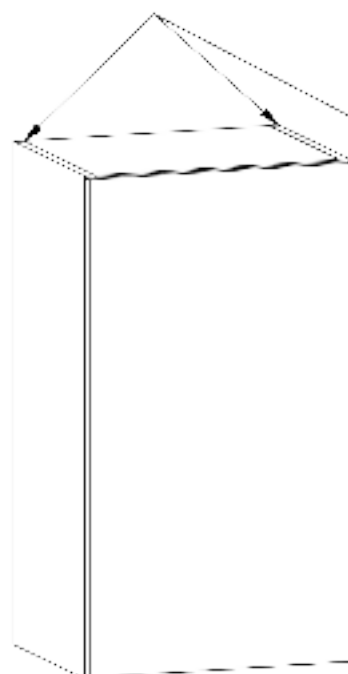
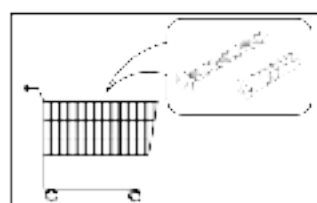
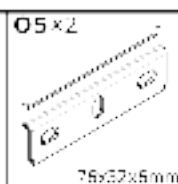

9

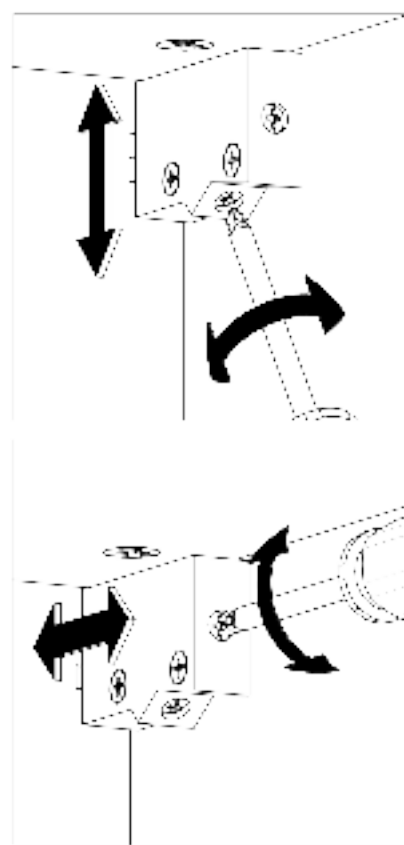
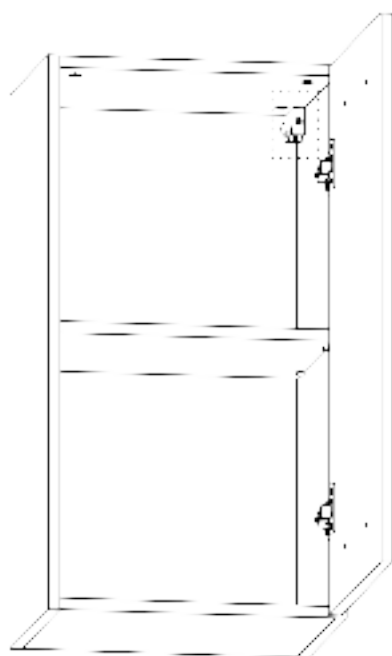

10

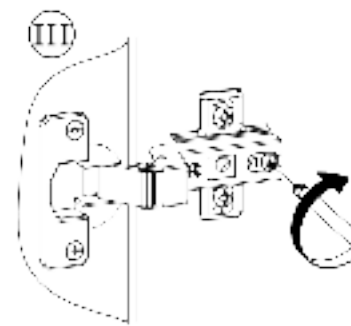
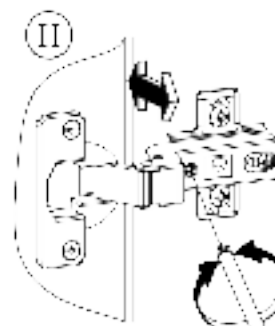
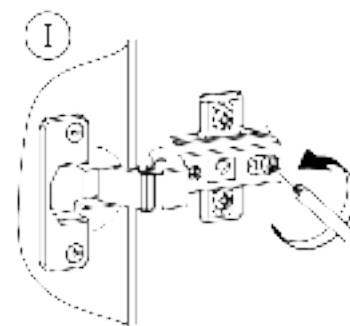
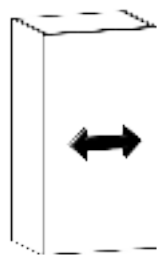
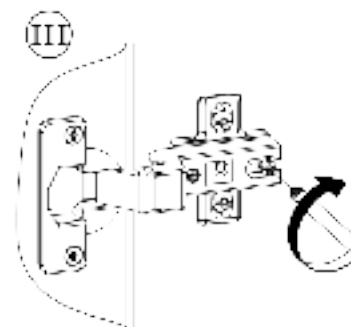
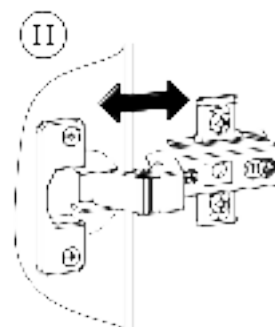
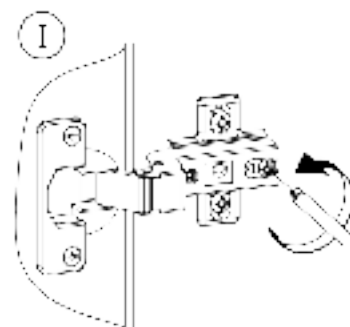
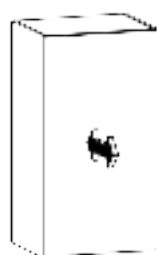
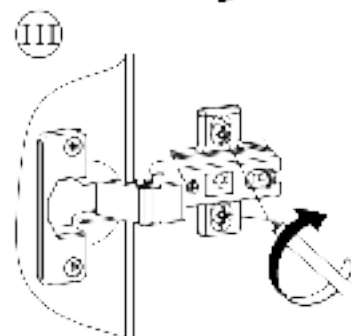
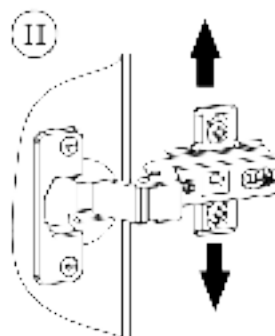
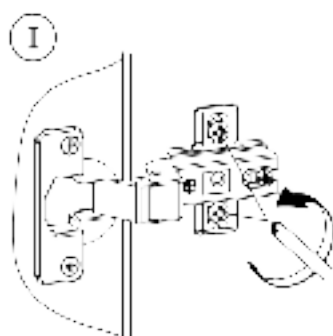
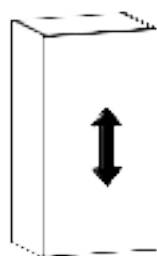

?

A

B

A

I20 x



83x7 x 11 mm

W2 x



Ø5,5x15 mm

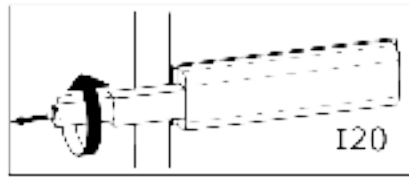

I20



I20

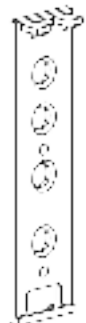

I20-a



I20-b

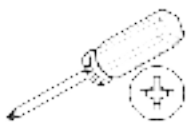
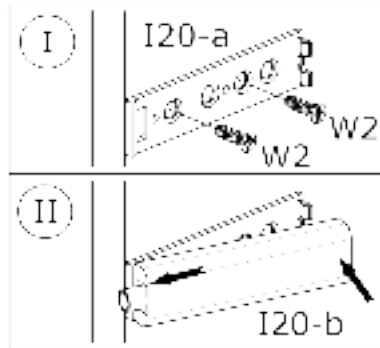
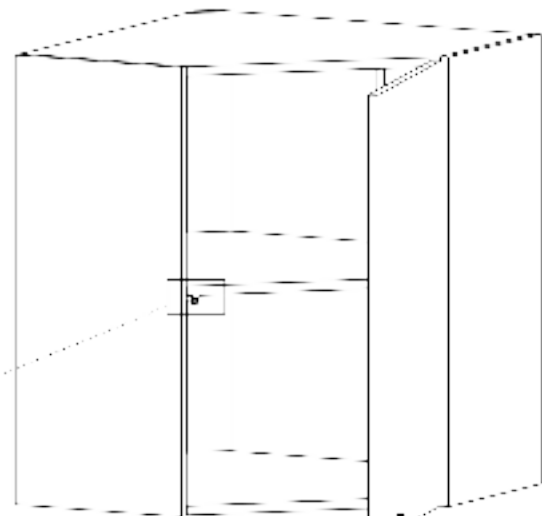
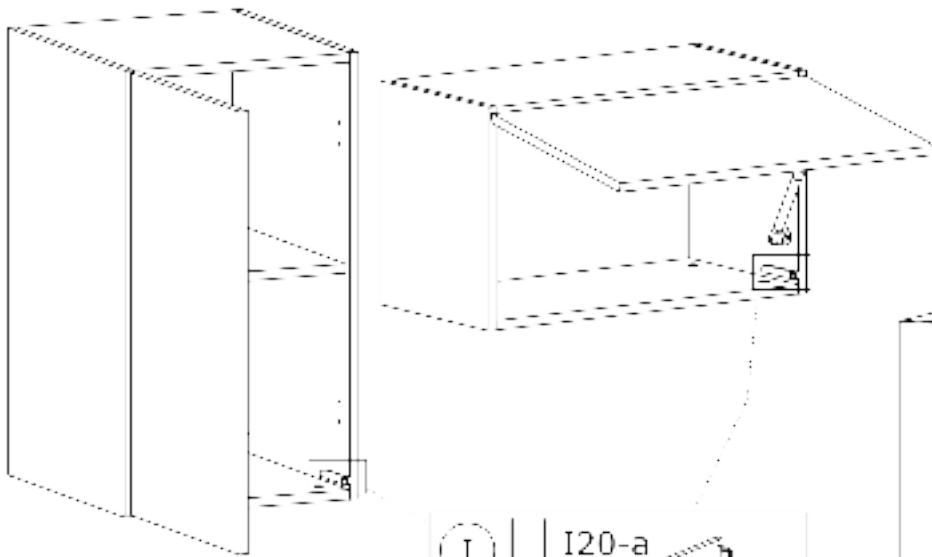

130 mm

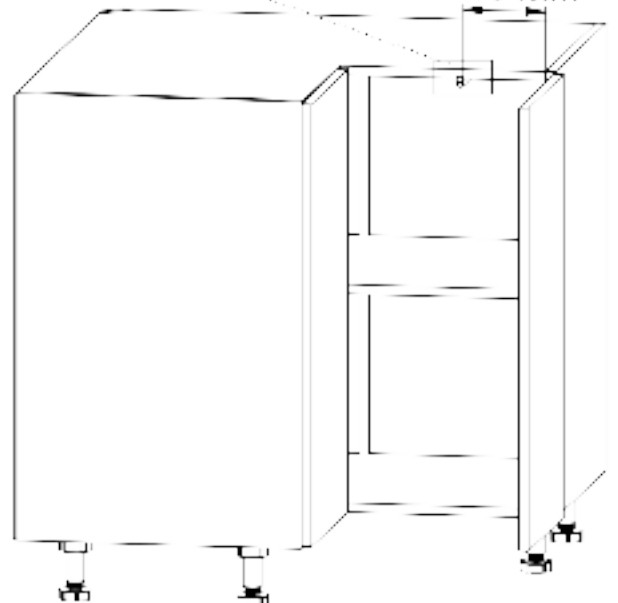
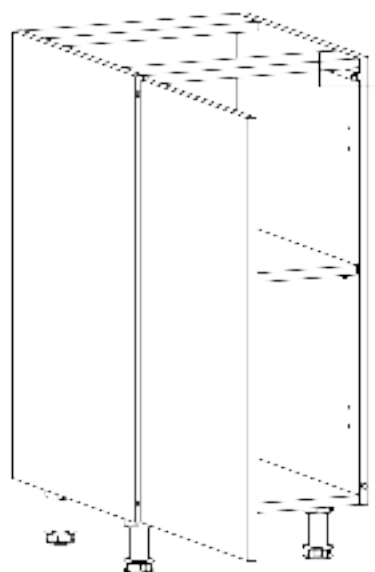

B

U18 / U19

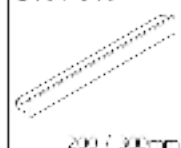

200 / 300mm

W5



04x30mm

Y1



Ø9x1.5mm

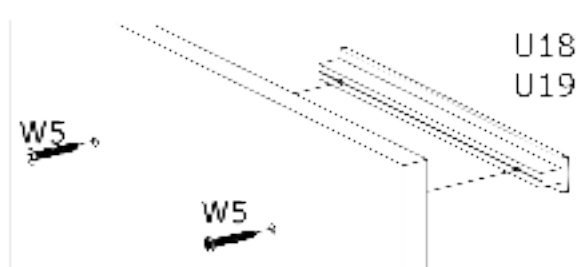

U18
U19

