

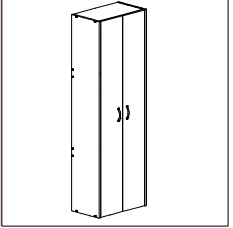

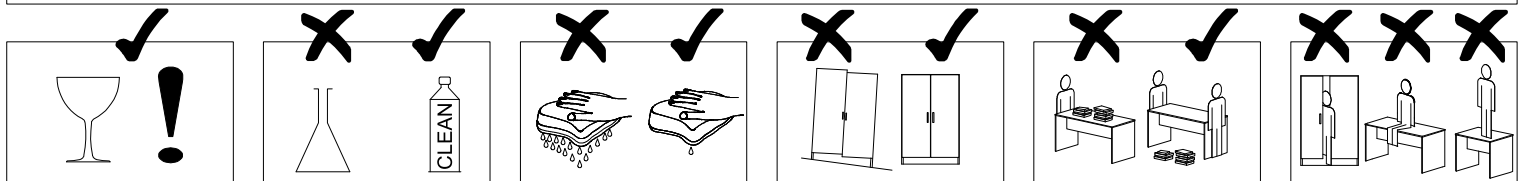

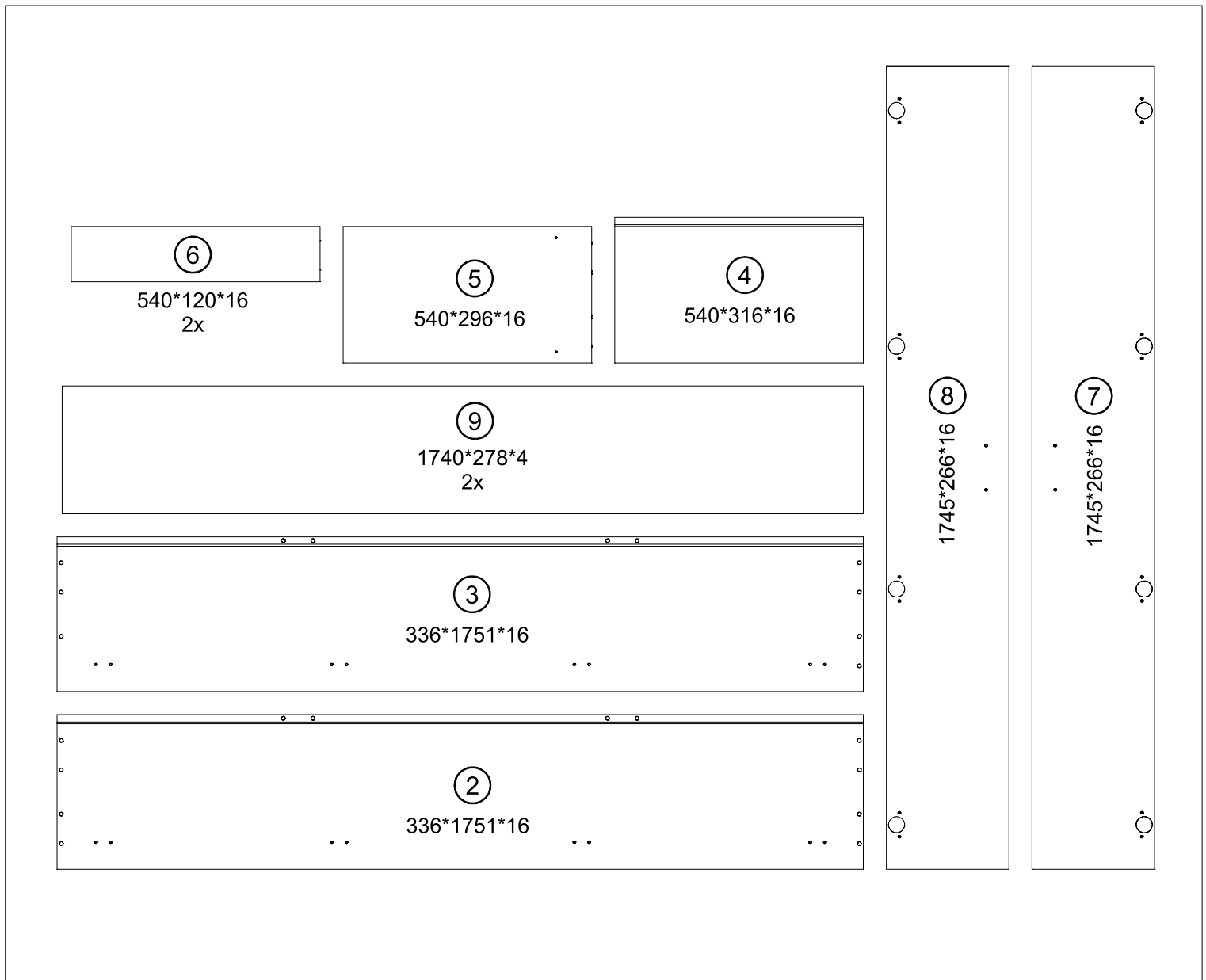

ASSISTANT
AS-006-00
 572*336*1751



Ø8x30			Ø4,5x16	Ø1,6x20															
A	8x	B	16x	C	16x	D	4x	E	6x	F	16x	G	2x	H	8x	J	8x	K	1x
0h 50min		4	5,5 x 125	≤ 0,5 kg	0,6m	3m													

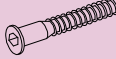

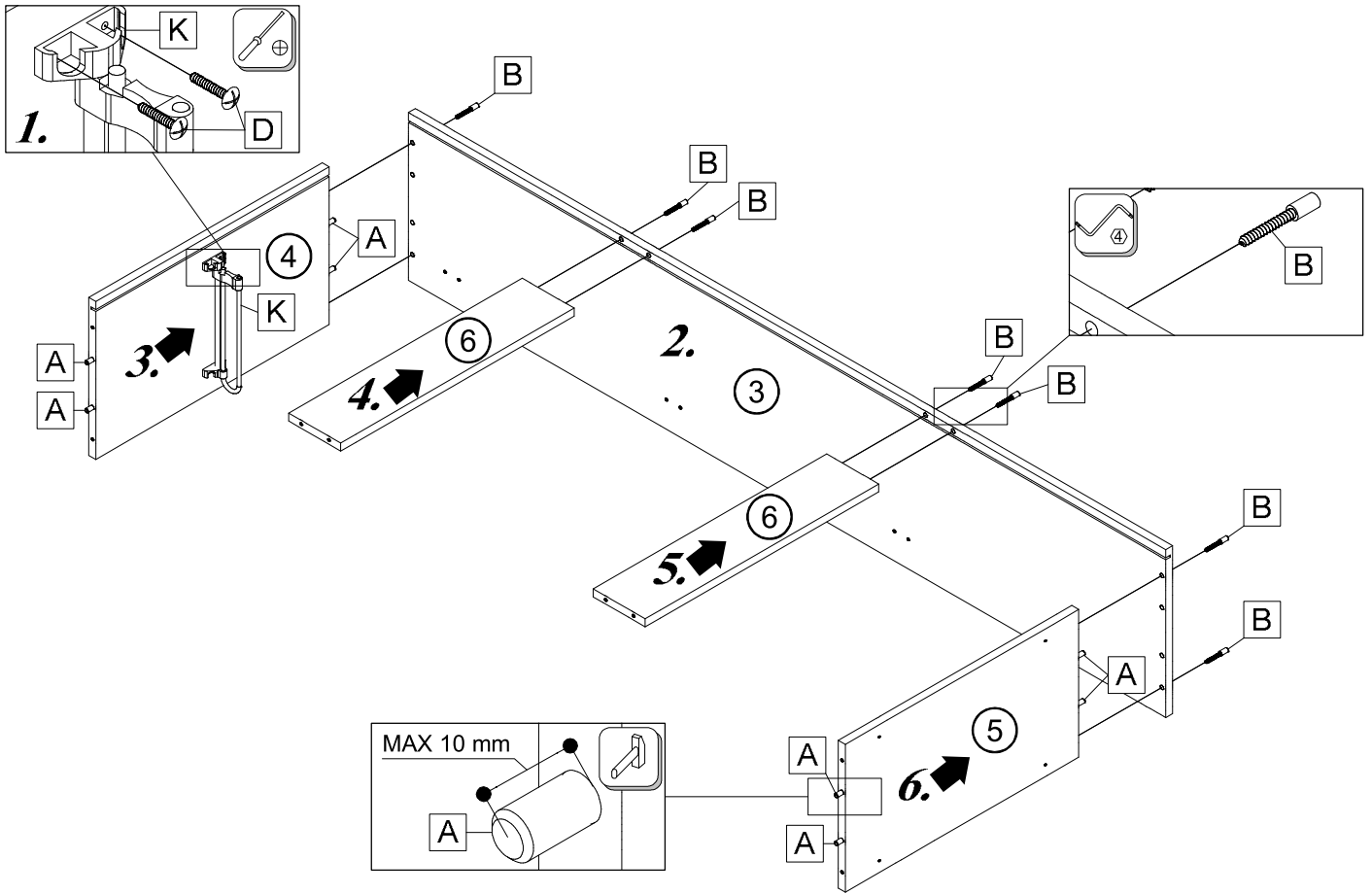

			
A 8x	B 8x	D 4x	K 1x

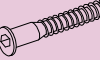

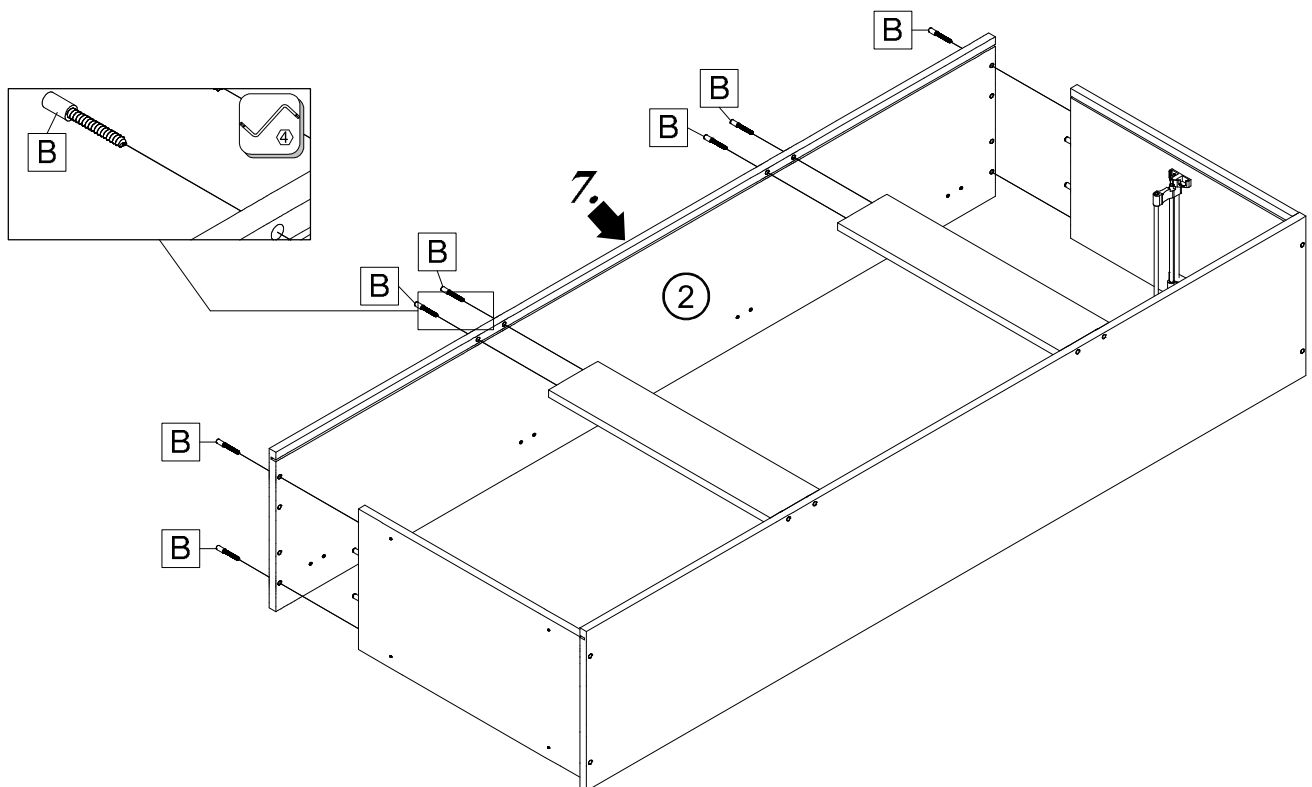
B 8x

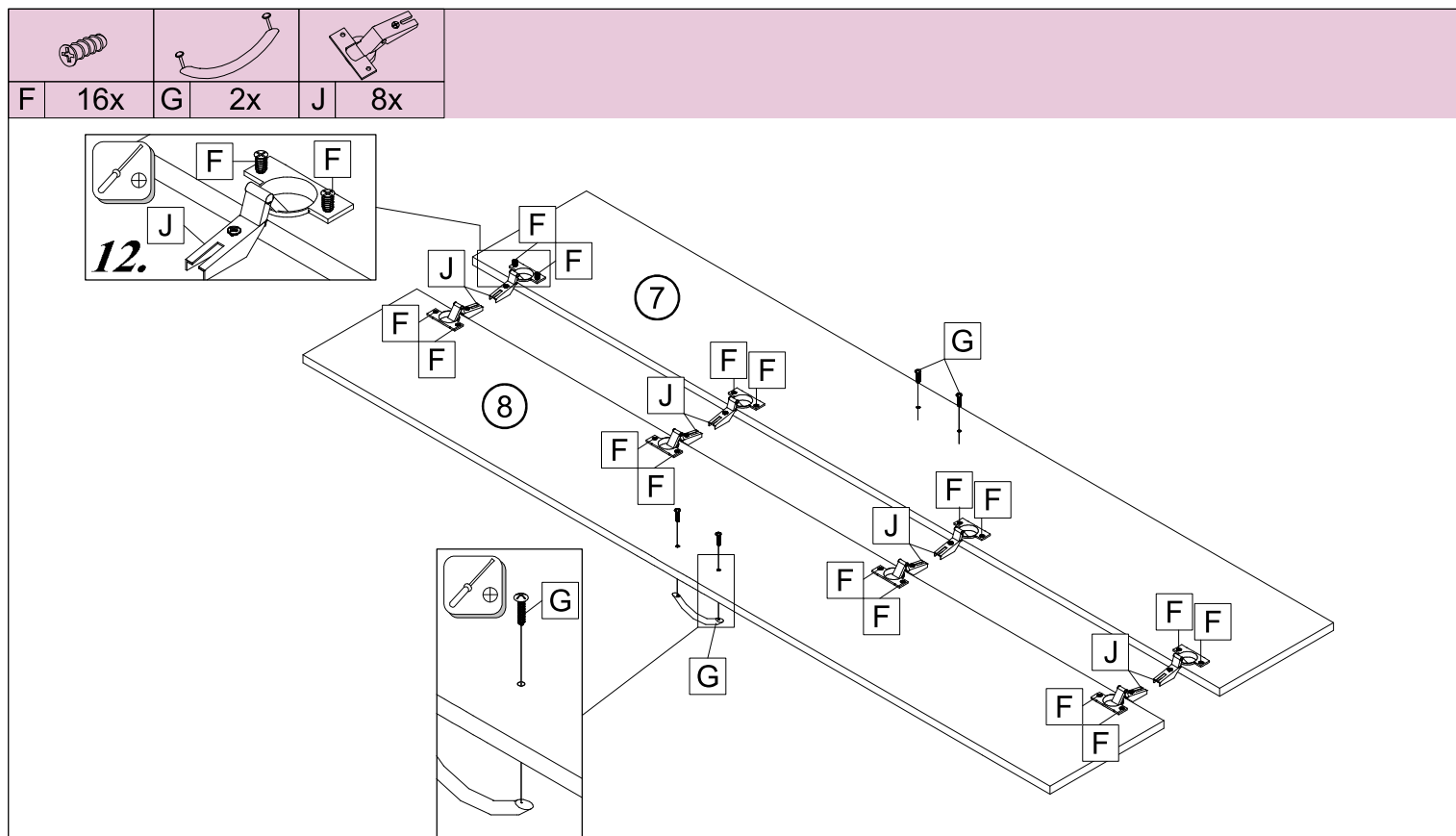
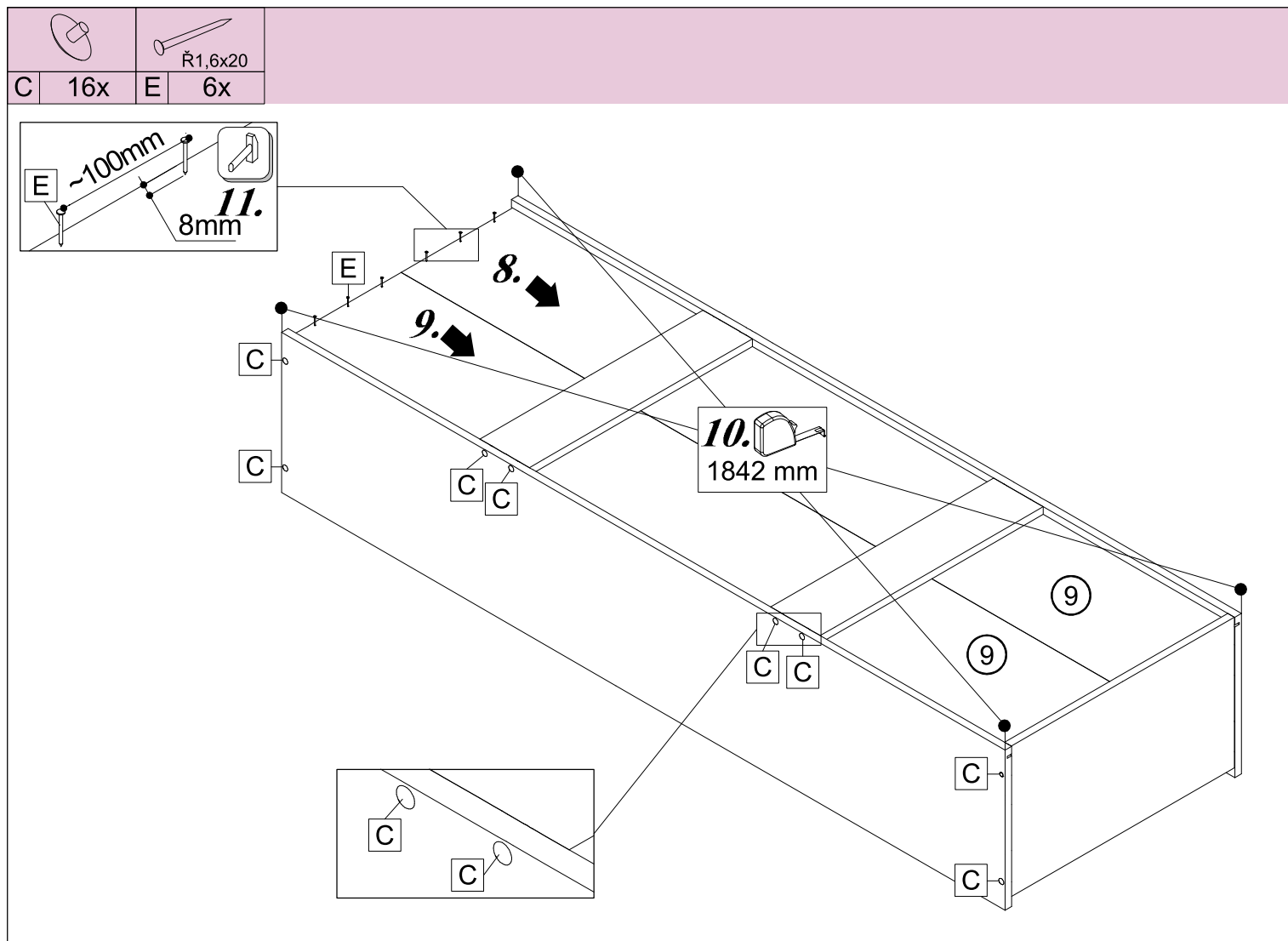



H 8x

