

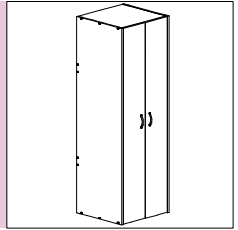





ASSISTANT
 AS-005-00
 572*550*1751



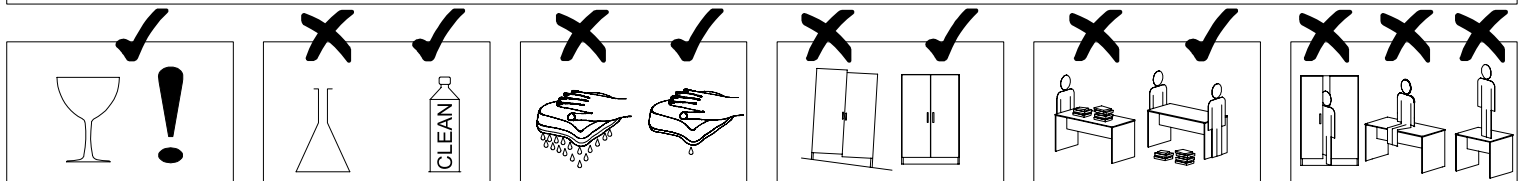
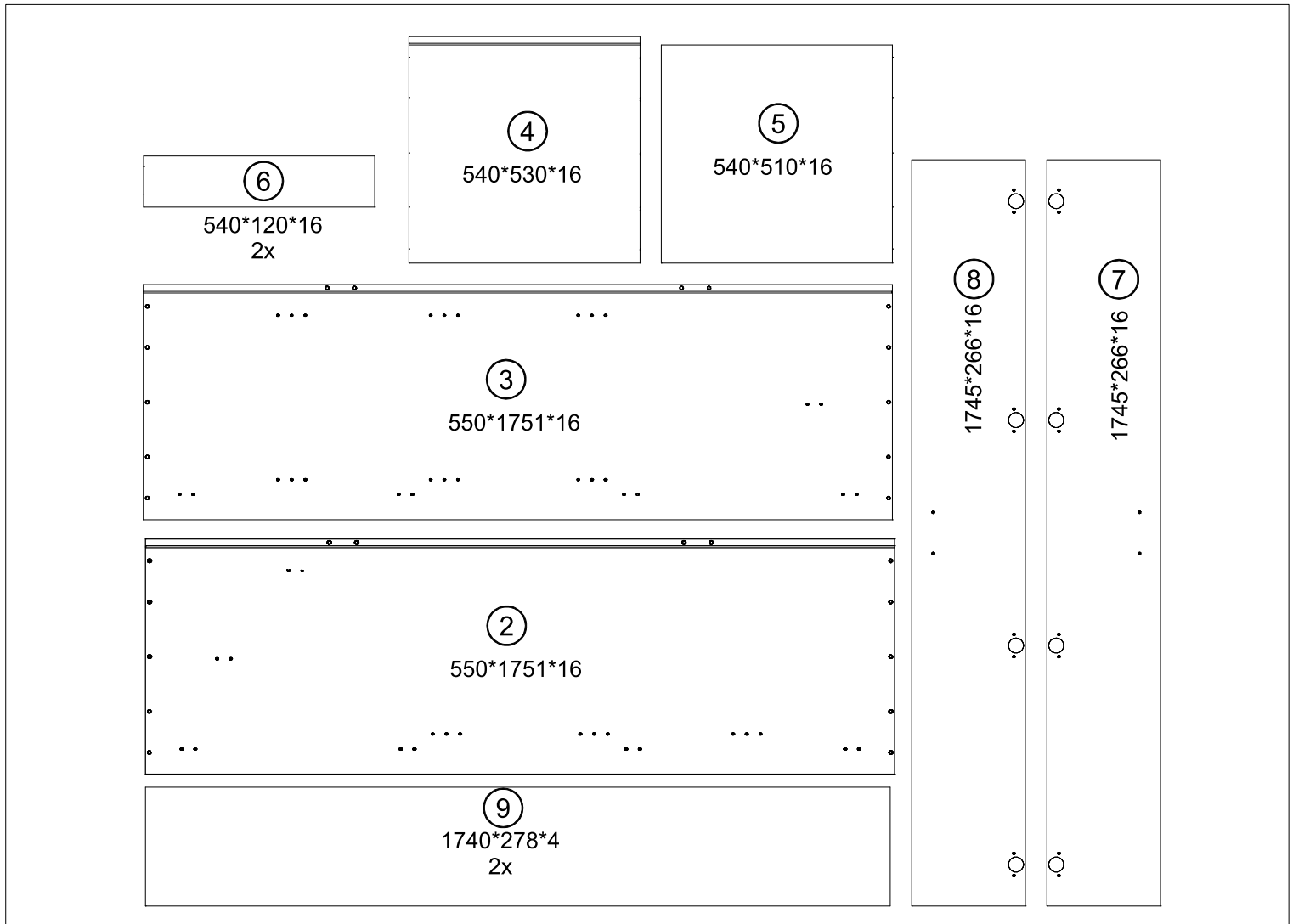

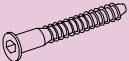
A 20	B 8x Ø1,6x20	C 8x Ø8x30	D 20x	E 6x Ø3,5x15	F 8x	G 8x	H 2x	J 16x	K 2x
L 1x									

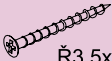
0h450min		4	5,54x4125	≤40,54kg	0,6m	3m	

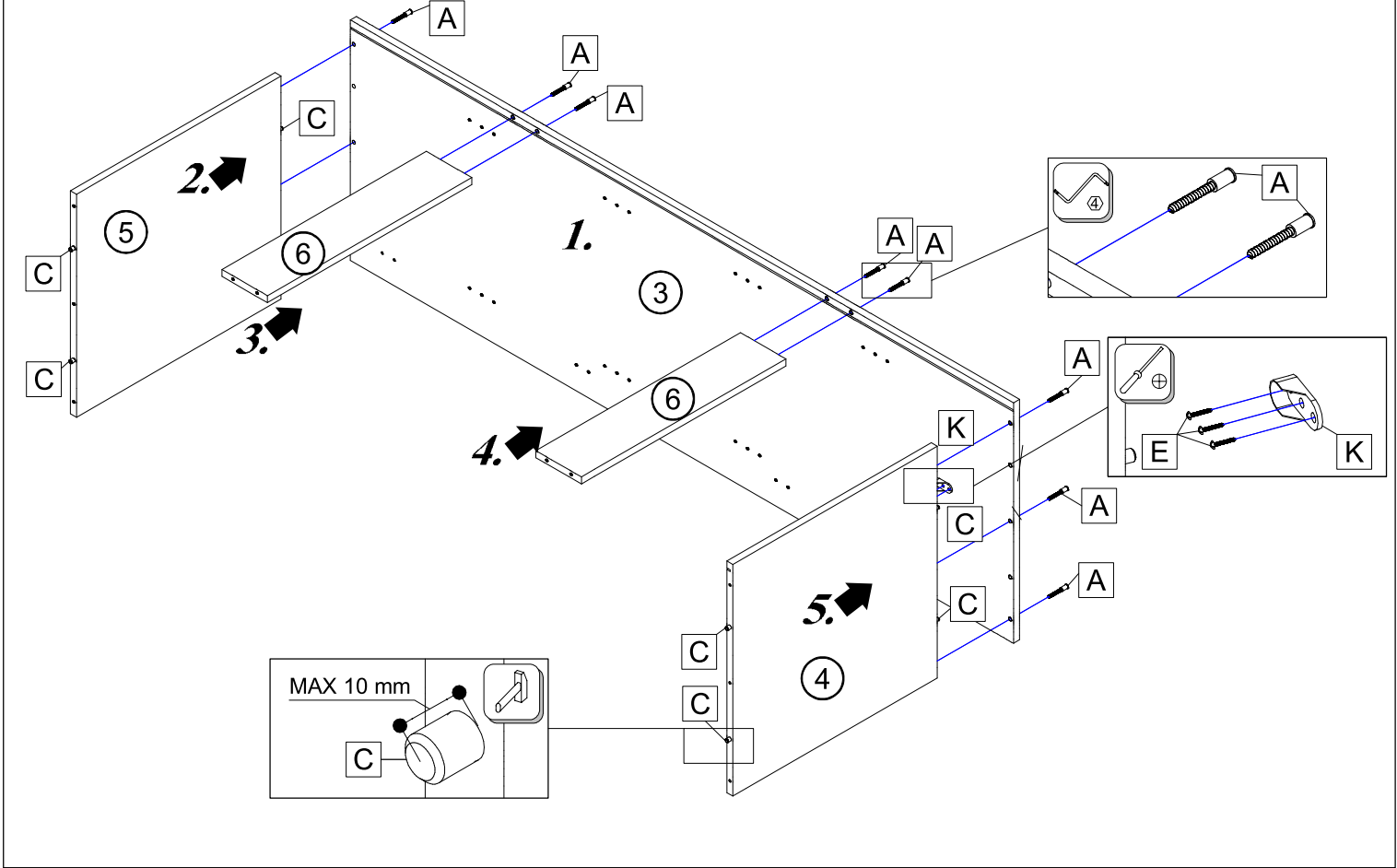

			
A 10x	C 8x	E 3x	K 1x

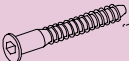

		
A 10x	E 3x	K 1x

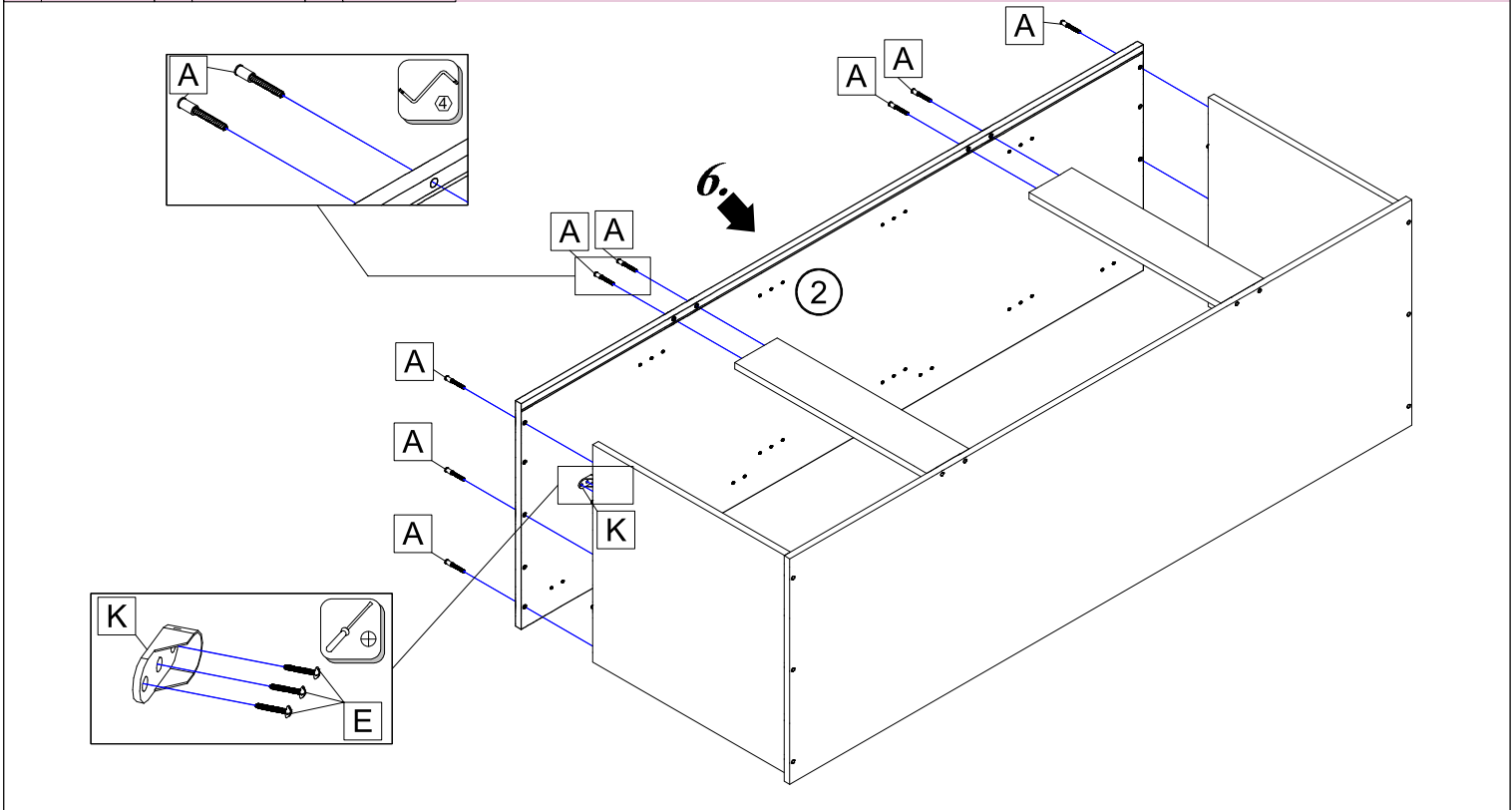

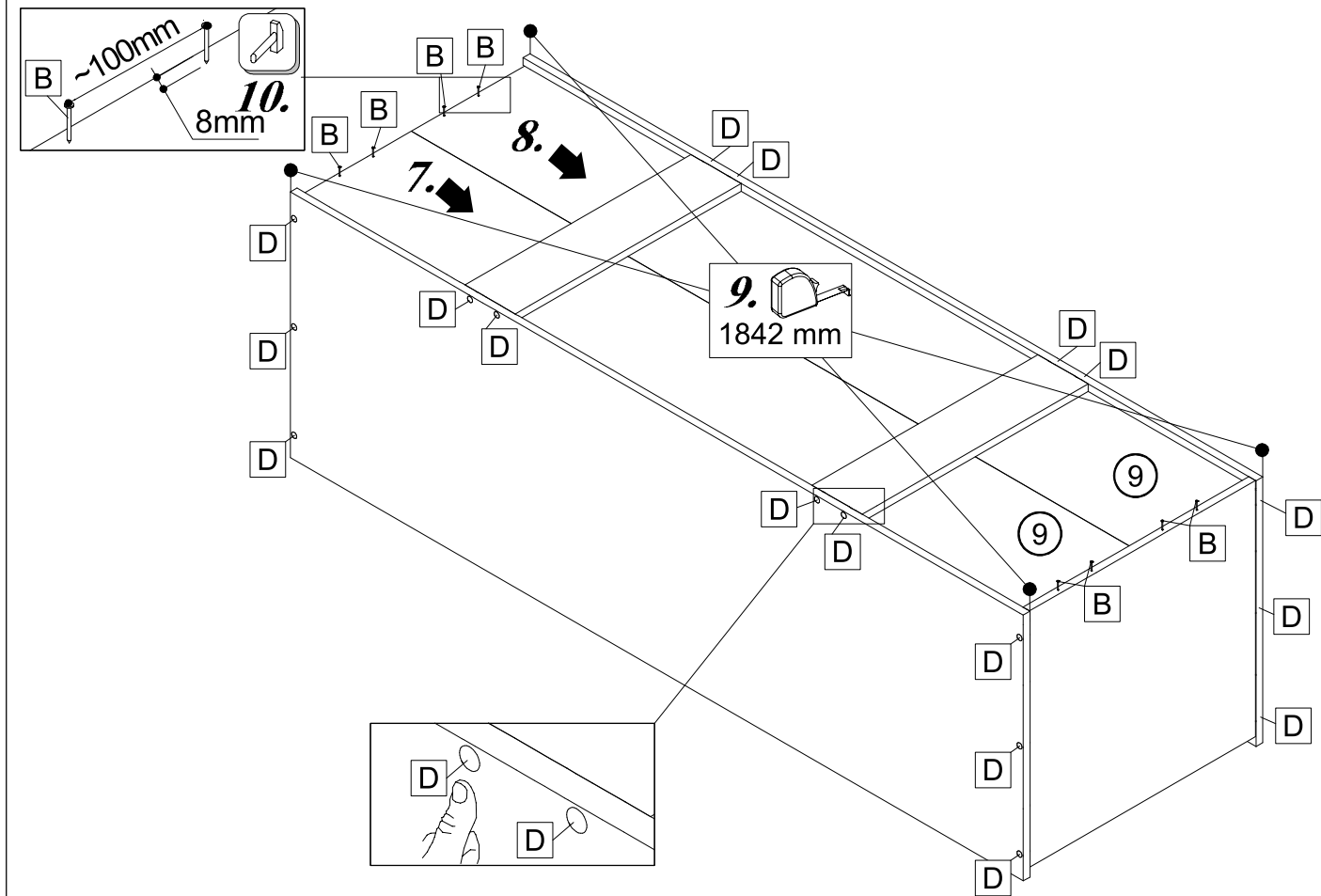

	Ř1,6x20		
B	8x	D	20x

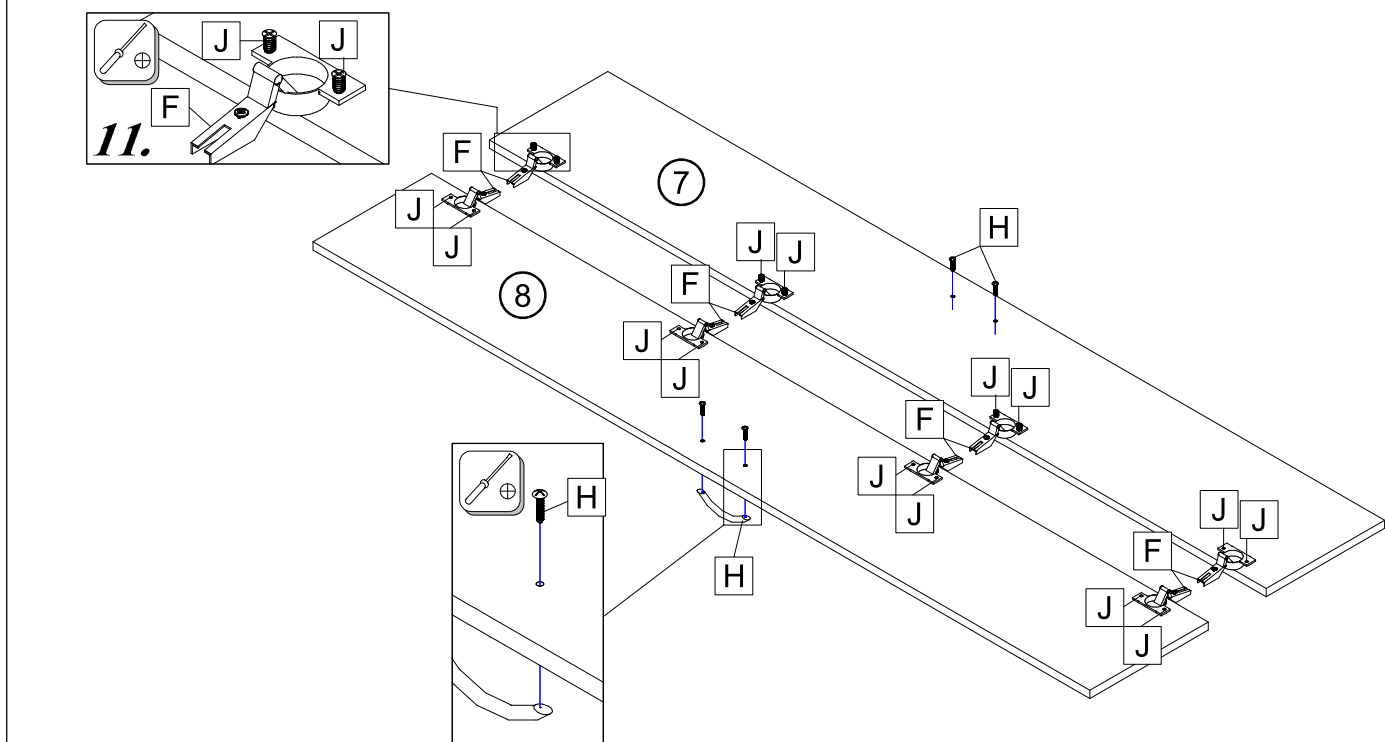

F	8x	H	2x	J	16x



	
G 8x	L 1x

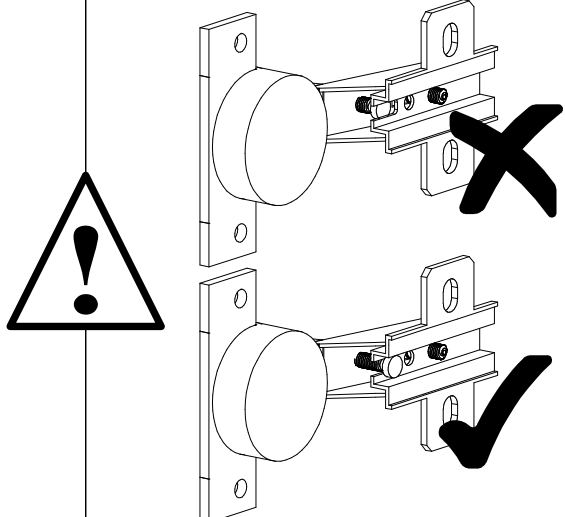
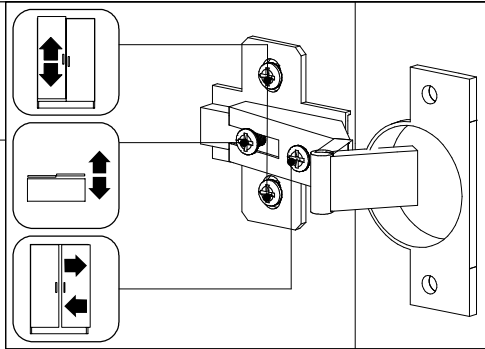
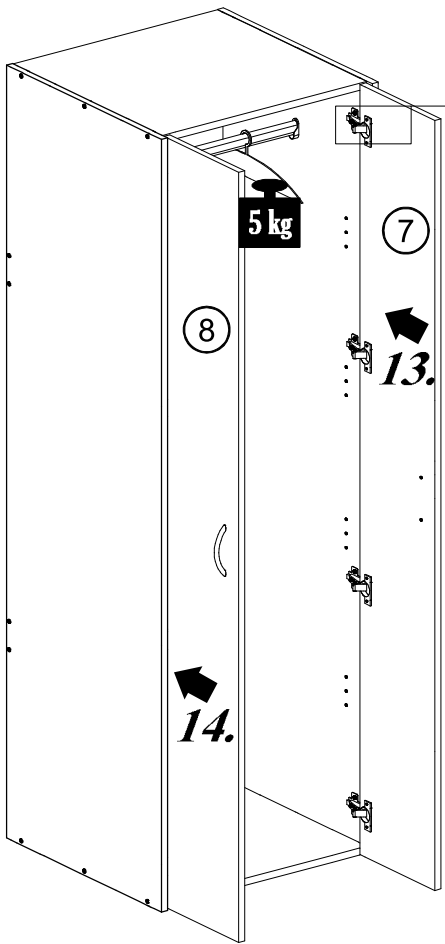
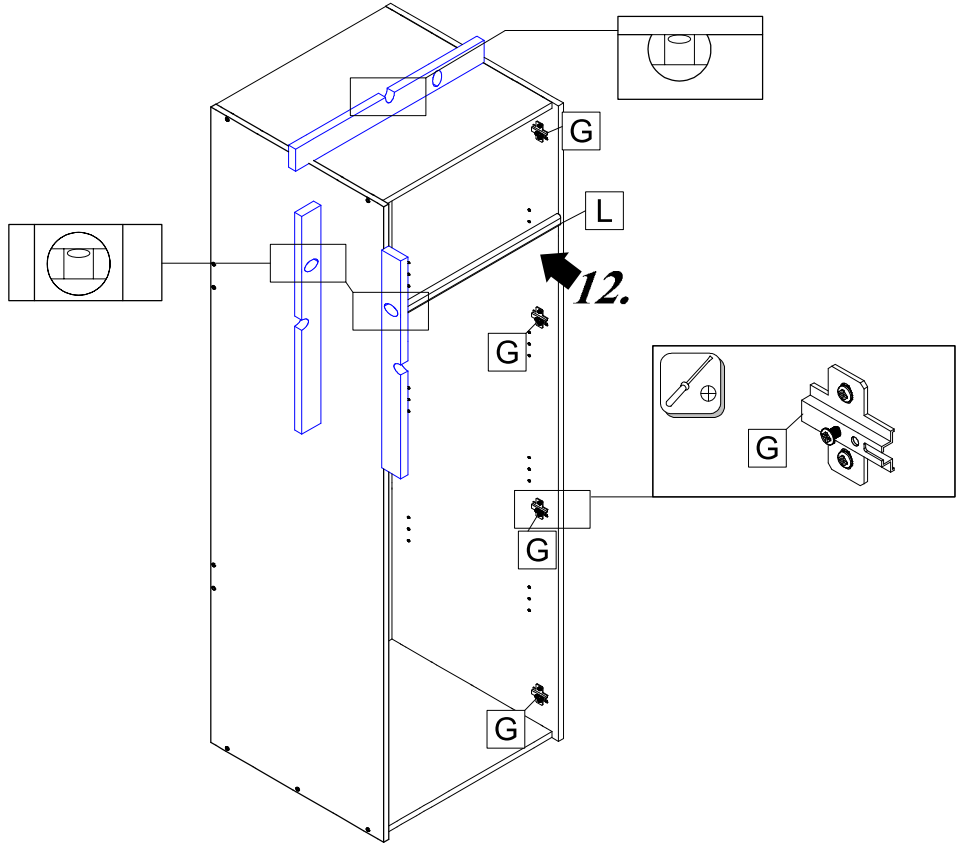

5 kg

7

13.

8

14.